

# 97671 97725

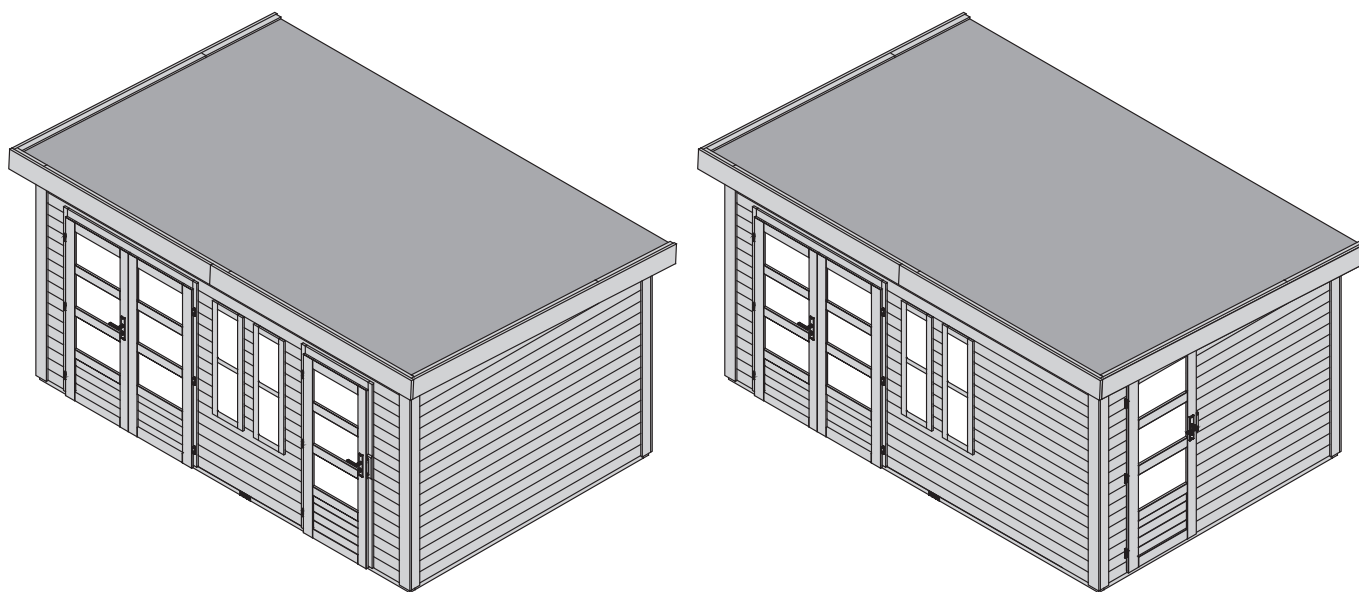

Das komplette  
Farbangebot  
finden Sie auf:



[www.KARIBU-FARBENSHOP.de](http://www.KARIBU-FARBENSHOP.de)

-  **Aufbauanleitung**
-  **Building Instructions**
-  **notice de montage**
-  **montagehandleiding**
-  **Montagevejledning**
-  **Instrucciones de construcción**
-  **Istruzioni per il montaggio**
-  **Montážní návod**
-  **Navodila za sestavljanje**





Bitte bewahren Sie die Anleitung und den Garantieschein zur Seriennummer auf.





Vernichten Sie diese erst nach Ablauf der Garantiezeit.

Eventuelle Beanstandungen können mithilfe der Stückliste einfacher zugeordnet werden.





#### Beigelegte Dokumente

- Informationsheft
- Garantieschein zur Seriennummer
- Typenschild inkl. Warnhinweise (Sauna)
- ggf. Zubehör-Anleitungen in externen Paketen





- \*  Nicht im Lieferumfang enthalten  
 Not included  
 Non comprises dans la livraison  
 Niet bijgeleverd

-  No forman parte del suministro  
 Non incluso  
 V ceně není zahrnuto  
 Ikke inkluderet

- 1  Länge muss ermittelt und zugesägt werden  
 Length must be determined and sawn  
 La longueur doit être déterminée et sciée  
 De lengte moet worden bepaald en worden gezaagd

-  La longitud debe ser determinada y aserrada  
 La lunghezza deve essere determinata e segata  
 Délka musí být určena a rozřezána  
 Længden skal bestemmes og saves





- 2  Nicht gebraucht  
 Not needed  
 Pas nécessaire  
 Niet nodig

-  No es necesario  
 Non necessario  
 Není nutná  
 Ikke nødvendigt





- 3  Mit Zubehör  
 With accessories  
 Avec accessoires  
 Met toebehoren

-  Con accesorios  
 Con accessori  
 S příslušenstvím  
 Med tilbehør

- 4  Fixiert vorübergehend  
 Fixed temporarily  
 Temporairement fixe  
 Tijdelijk vast

-  Temporalmente fijo  
 Temporaneamente fisso  
 Dočasně pevný  
 Midlertidigt rettet

- 5  Bestand vom Haus  
 Inventory of the house  
 Inventaire de la maison  
 Inventaris von het huis

-  Inventario de la casa  
 Inventario della casa  
 Inventář domu  
 Inventar af huset

 Vergleichen Sie zuerst die Material-liste mit Ihrem Paketinhalt! Bitte haben Sie Verständnis, dass Beanstandungen nur im nicht aufgebauten Zustand bearbeitet werden können!

 First compare the list of materials with your package contents! Please understand that complaints can be processed in the non-built status only!

 Commencez par comparer la liste du matériel avec le contenu de votre paquet! Sachez que nous traitons uniquement les réclamations concernant le matériel à l'état non monté!

 Vergelijk eerst de lijst van materialen met de inhoud van uw pakket! Reclamaties kunnen alleen in behandeling worden genomen zolang de onderdelen nog niet zijn gemonteerd!

 Start med at kontrollere materialelisten med indholdet af den leverede pakke! Vi gør venligst opmærksom på at reklamationer kun kan behandles for materialer som ikke er blevet bearbejdet!



 En primer lugar, compare la lista de material con el contenido del paquete. Rogamos entienda que las reclamaciones sólo pueden ser tramitadas antes de montar el objeto!

 Confrontate questa distinta materiali prima con il contenuto del pacchetto! Vi preghiamo di comprendere che eventuali reclami possono essere accolti solo prima del montaggio!

 Nejprve přezkontrolujte obsah balení podle materiálového listu! Mějte pochopení pro to, že případnou reklamaci se můžeme zabývat pouze tehdy, když díly nebudou smontované! Za pomoci tohoto seznamu můžete jednotlivé díly přiřadit k montážnímu návodu.

 Najprej primerajte zoznam materialov z vebino vašega paketa! Upoštevajte, da lahko pritožbe obravnavamo le v nesestavljenem stanju!





		
1 x <b>A1</b>	683 x 38 x 18 mm	ID 98319
1 x <b>A2</b>	1400 x 38 x 18 mm	ID 70102
9 x <b>A3</b>	1817 x 45 x 18 mm	ID 46767
10 x <b>A4</b>	2100 x 45 x 18 mm	ID 19547
2 x <b>A5</b>	716 x 78 x 18 mm	ID 98316
2 x <b>A6</b>	1428 x 78 x 18 mm	ID 55028
1 x <b>A7</b>	200 x 95 x 18 mm	ID 28440
4 x <b>A8</b>	2175 x 95 x 18 mm	ID 70235
4 x <b>A9</b>	2175 x 120 x 18 mm	ID 70234
18 x <b>A10</b>	150 x 140 x 26 mm	ID 63591
8 x <b>A11</b>	605 x 140 x 26 mm	ID 65321
9 x <b>A12</b>	1268 x 140 x 26 mm	ID 63589
9 x <b>A13</b>	2854 x 140 x 26 mm	ID 21089
2 x <b>A14</b>	2290 x 190 x 26 mm	ID 63587
2 x <b>A15</b>	3000 x 190 x 26 mm	ID 12390
4 x <b>A16</b>	2100 x 58 x 28 mm	ID 42504
1 x <b>A17</b>	763 x 38 x 38 mm	ID 98247
1 x <b>A18</b>	1475 x 38 x 38 mm	ID 44840
4 x <b>A19</b>	1724 x 38 x 38 mm	ID 43522
2 x <b>A20</b>	1875 x 60 x 40 mm	ID 99469
2 x <b>A21</b>	2345 x 60 x 40 mm	ID 39752
3 x <b>A22</b>	2600 x 60 x 40 mm	ID 99470
2 x <b>A23</b>	2204 x 45 x 45 mm	ID 54378
4 x <b>A24</b>	2167 x 68 x 68 mm	ID 67676

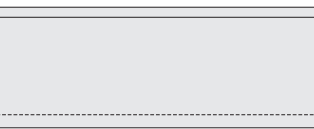

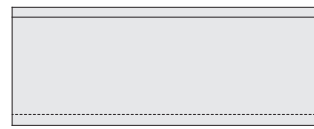
	
1 x	ID 16034

		
16 x <b>W1</b>	2650 x 121 x 28 mm	ID 53714

		
16 x <b>W2</b>	275 x 121 x 38 mm	ID 85964
16 x <b>W3</b>	2390 x 121 x 38 mm	ID 42365
34 x <b>W4</b>	2650 x 121 x 38 mm	ID 70229
23 x <b>W5</b>	4150 x 121 x 38 mm	ID 70112

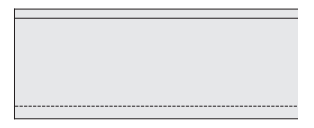
		
1 x <b>W6</b>	2650 x 87 x 28 mm	ID 99608

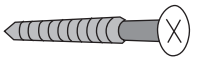
		
52 x <b>R1</b>	3000 x 96 x 19 mm	ID 19570

		
8 x	4 x 18 mm	ID 21191
200 x	4 x 30 mm	ID 3686
45 x	4 x 40 mm	ID 21925
280 x	4 x 50 mm	ID 3688
12 x	4,5 x 80 mm	ID 9204
710 x	5 x 70 mm	ID 93009

	
520 x	ID 5621

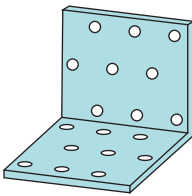
	
12 x	ID 14041

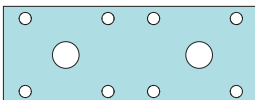
	
2 x	ID 62656



2 x <b>D1</b>	1765 x 717 x 36 mm	ID 31246
1 x <b>D2</b>	1765 x 717 x 36 mm	ID 31248

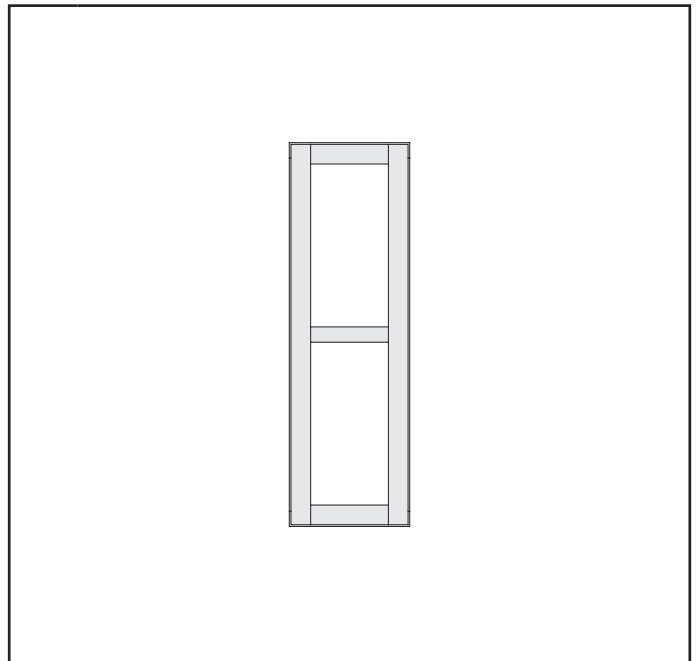

2 x <b>F1</b>	1130 x 355 x 38 mm	ID 70237
---------------	--------------------	----------

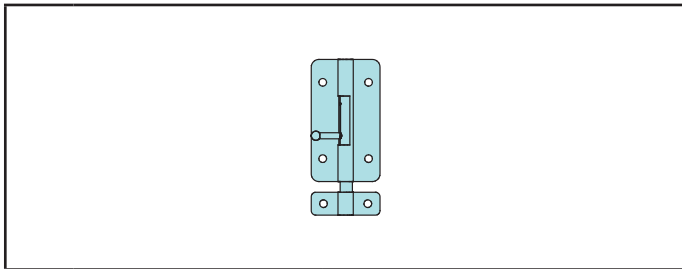

2 x		ID 3709
-----	--	---------

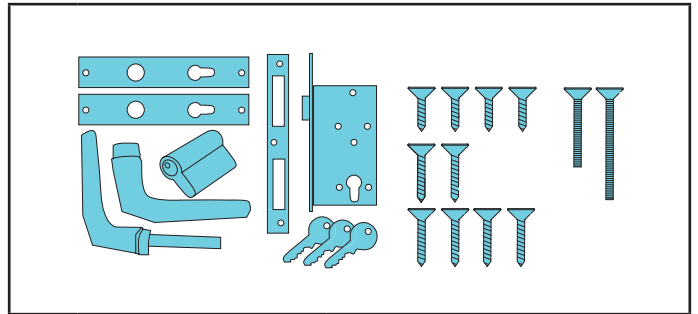

2 x		ID 15979
-----	--	----------

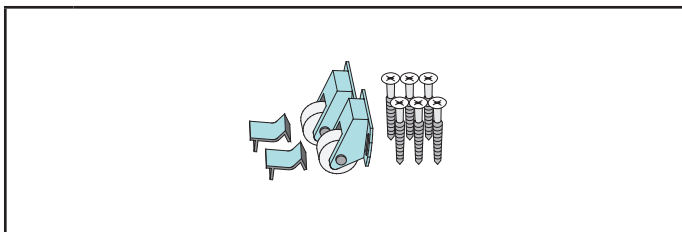

1 x		ID 68586
-----	--	----------

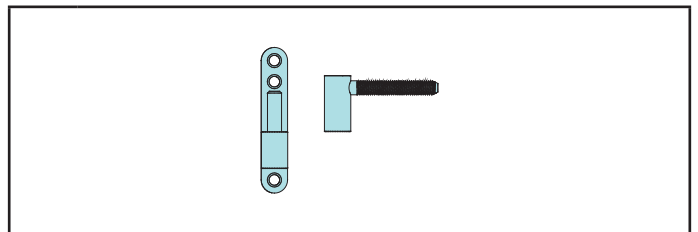

9 x		ID 3717
-----	--	---------

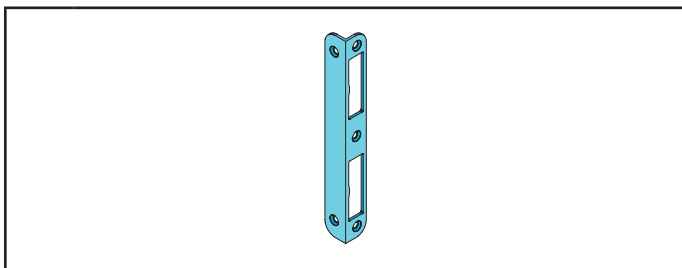

1 x <b>D8</b>		ID 71502
---------------	--	----------

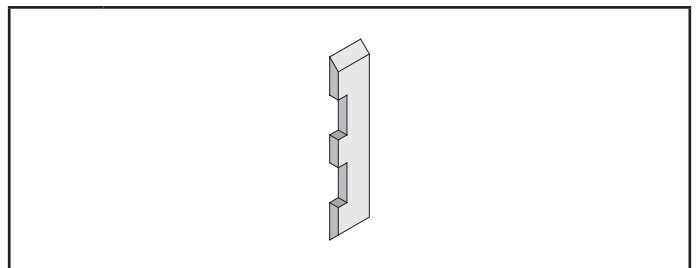

1 x		ID 99382
-----	--	----------

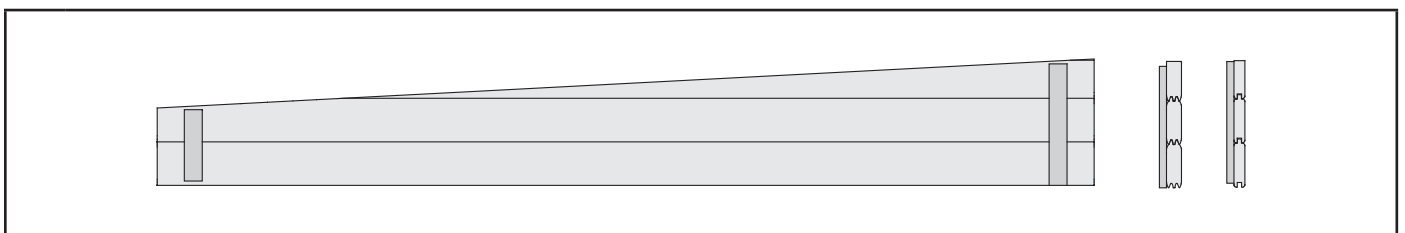

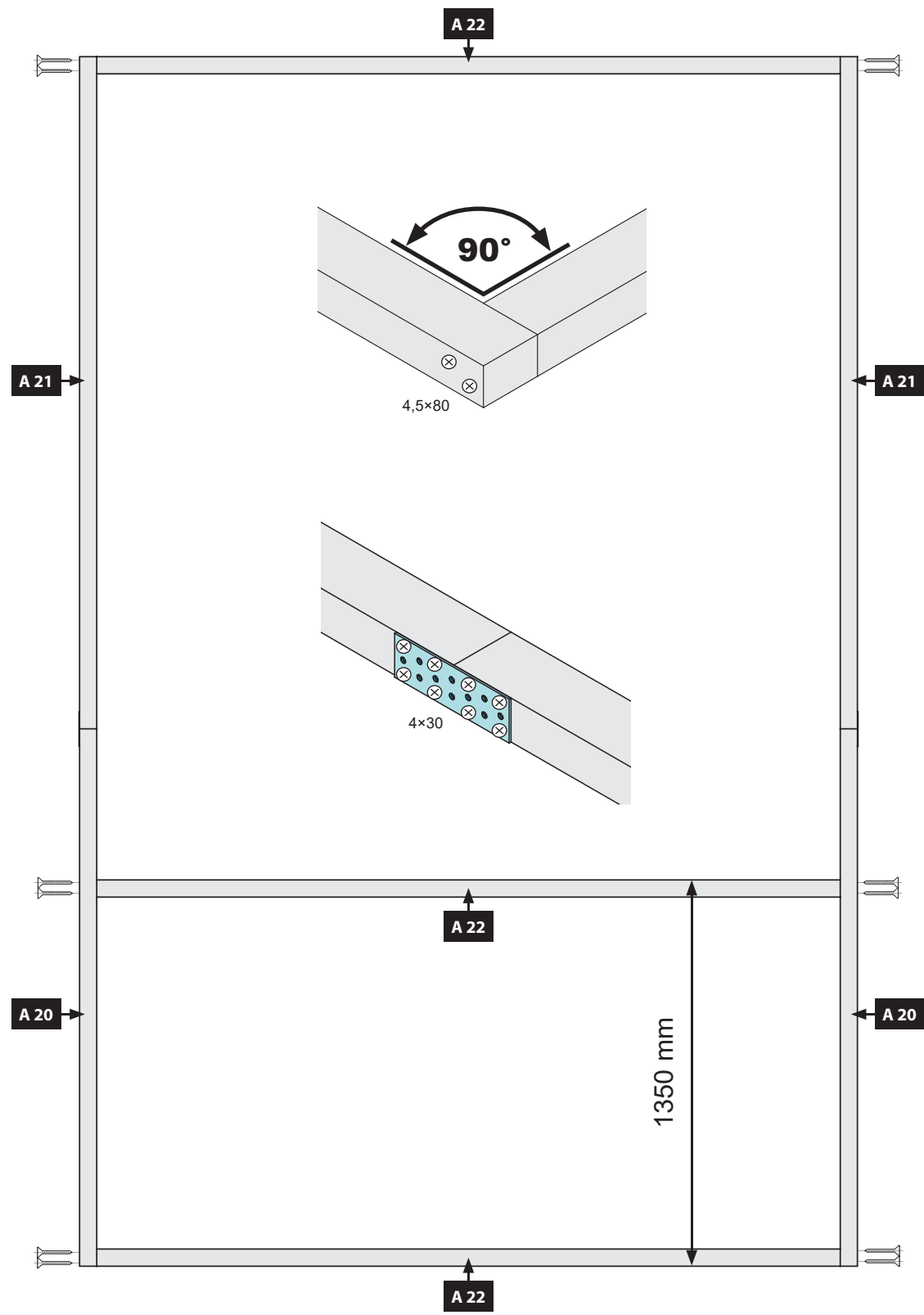
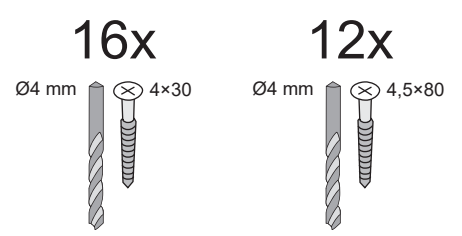

1 x <b>G1</b>	2650 x 317 x 28 mm	ID 63593
1 x <b>G2</b>	2650 x 317 x 38 mm	ID 70228
1 x <b>G3</b>	2650 x 317 x 38 mm	ID 70227

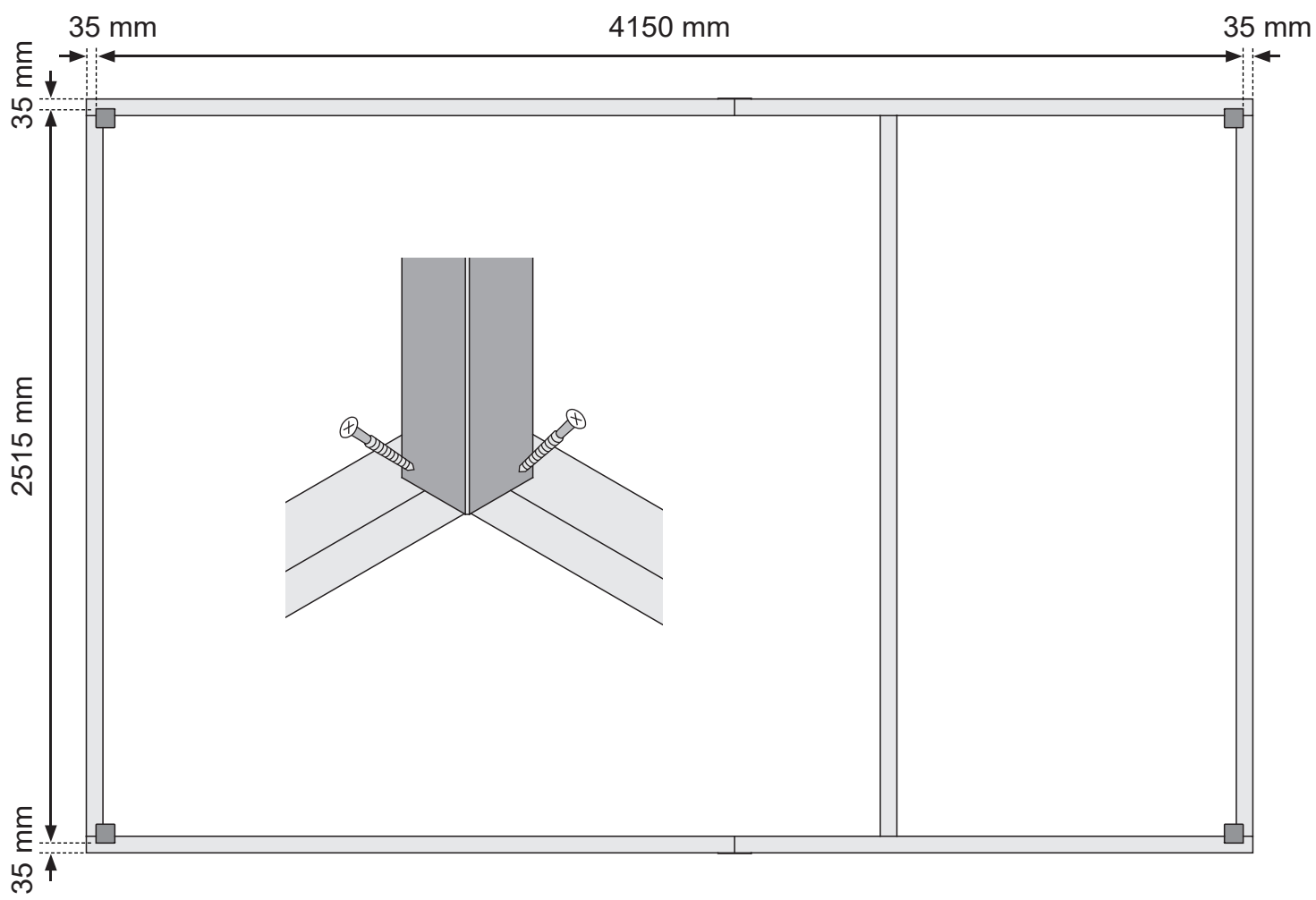
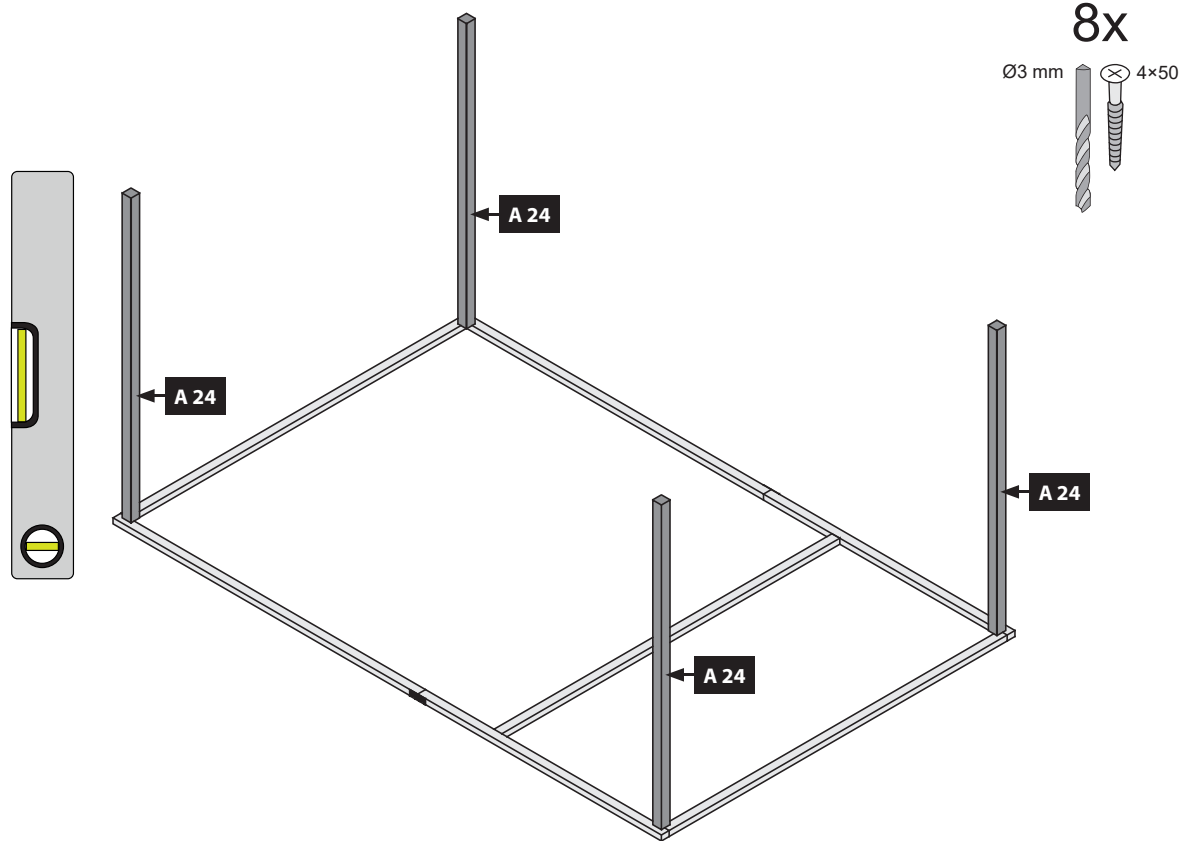

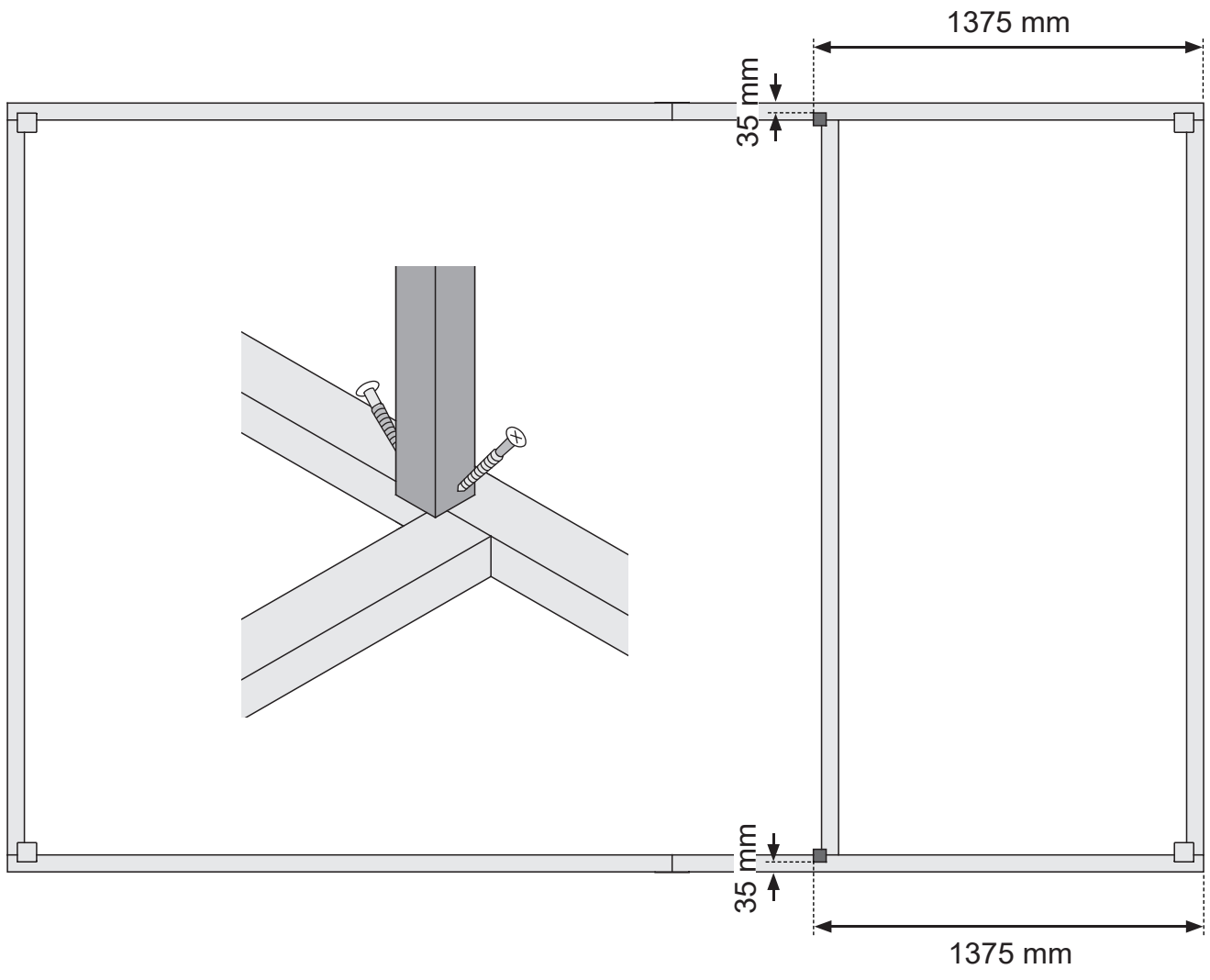
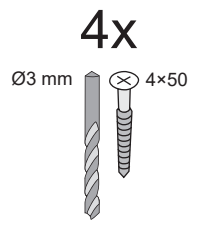
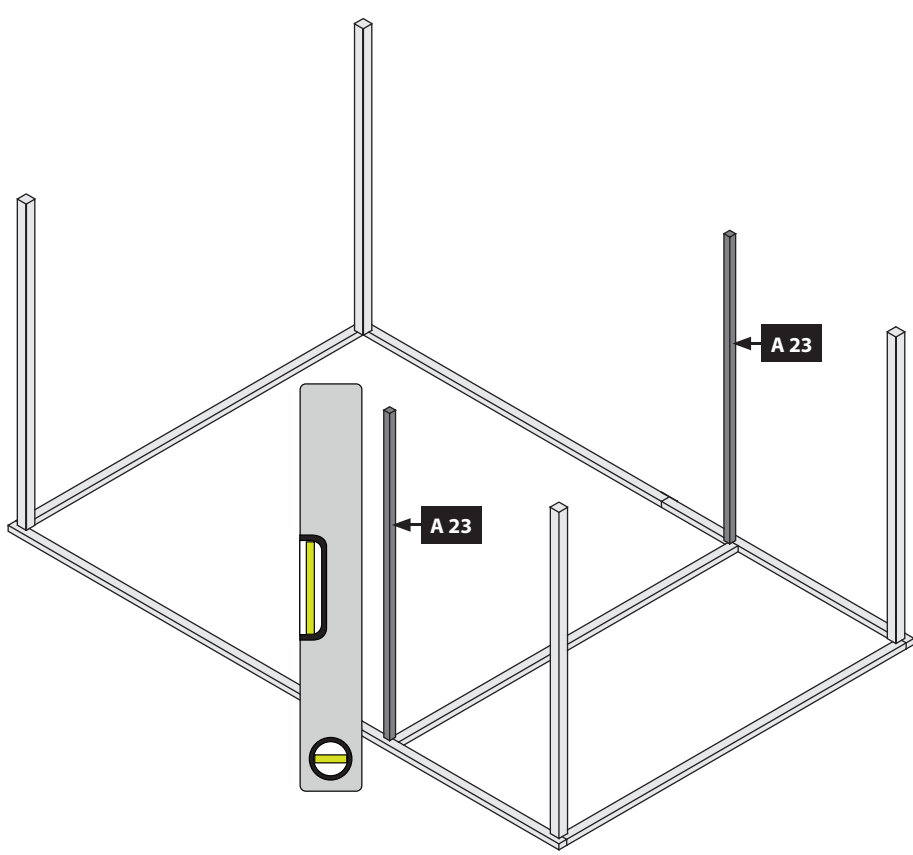





 Leim! Achten Sie auf die gleiche Höhe

 Glue! Look for the same height

 Colle! Faites attention à la même hauteur

 Lijm! Besteed aandacht aan de dezelfde hoogte

 Lim! Vær opmærksom på samme højde

 Pegamento! Prestar atención a la misma altura

 Colla! Prestare attenzione alla stessa altezza

 Klíč! Dávejte pozor na stejnou výšku

 Lepilo! Prepričajte se, da je višina enaka

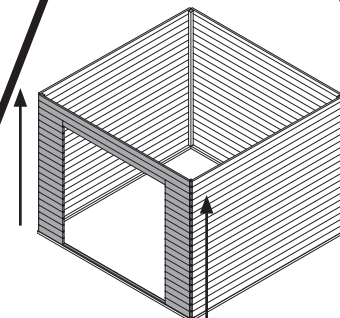
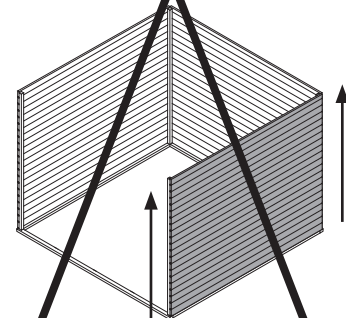
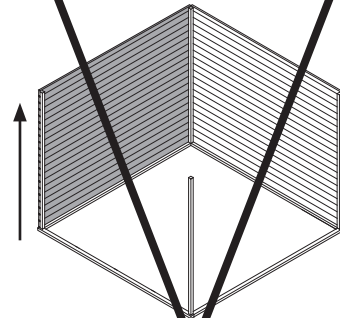
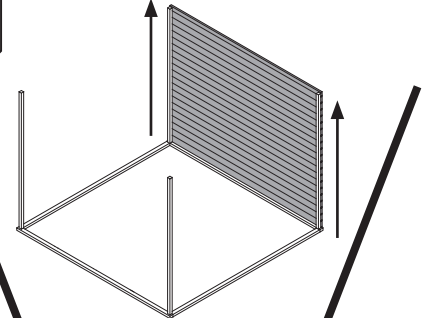
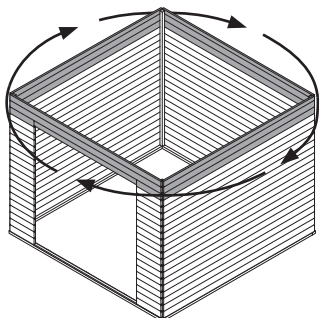
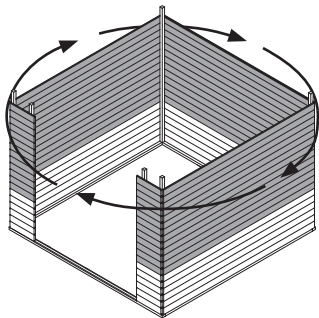
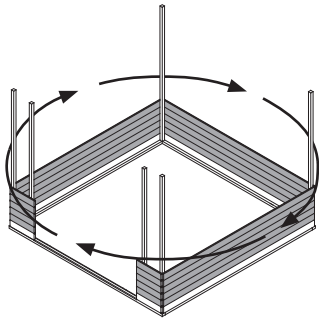
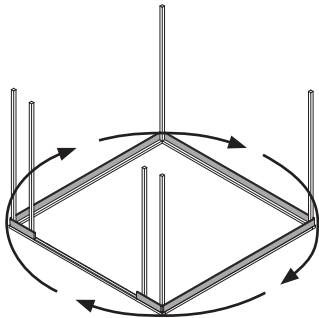
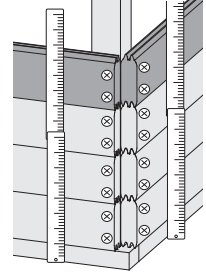
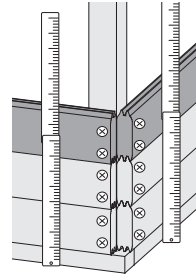
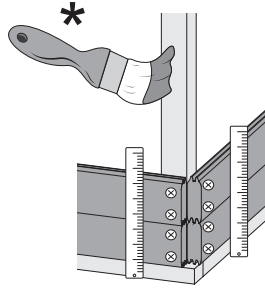
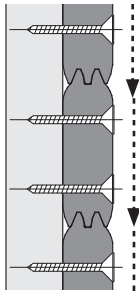



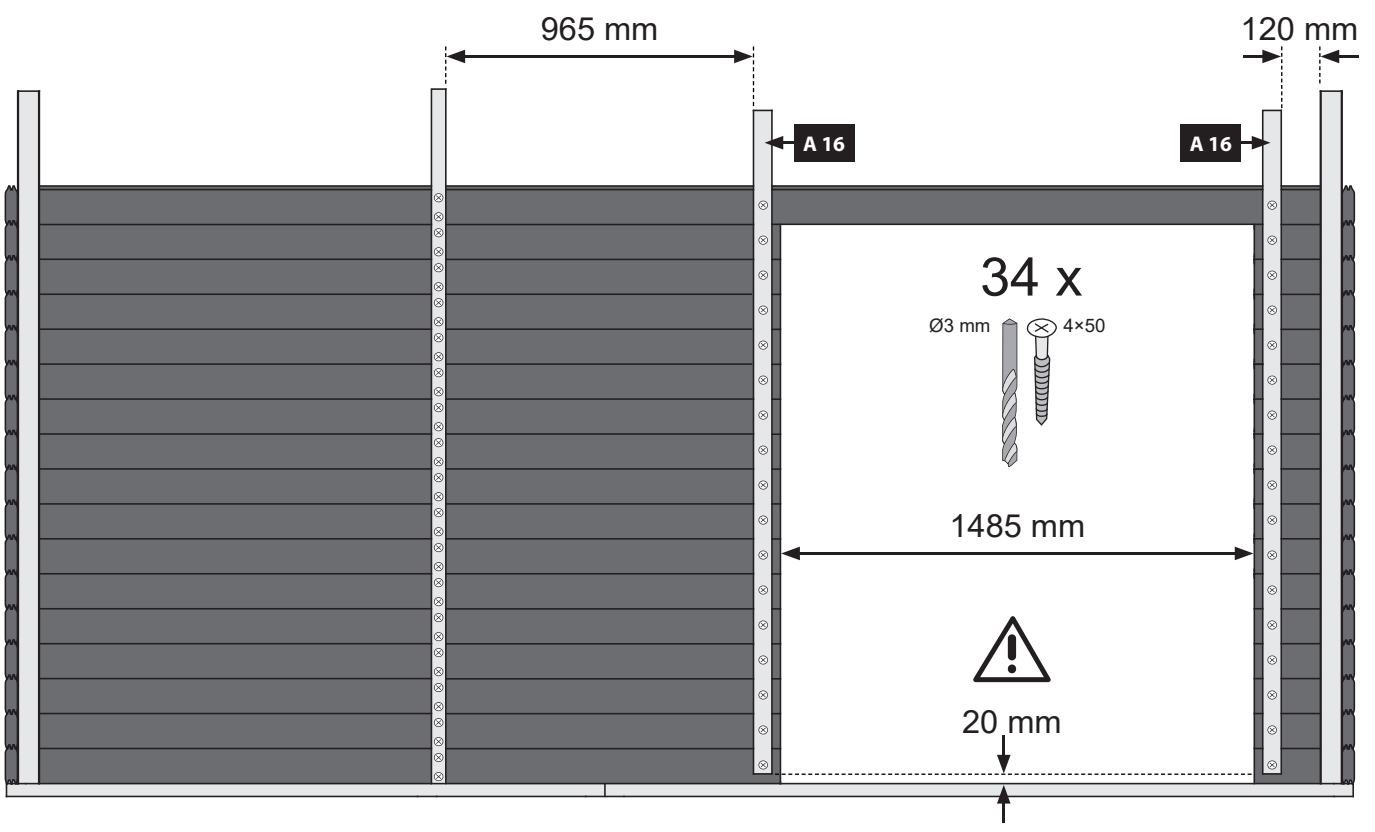
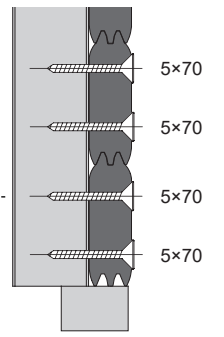
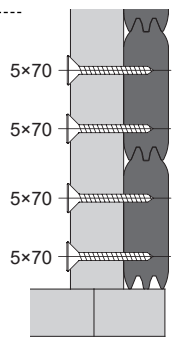
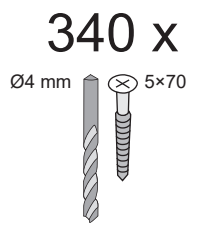
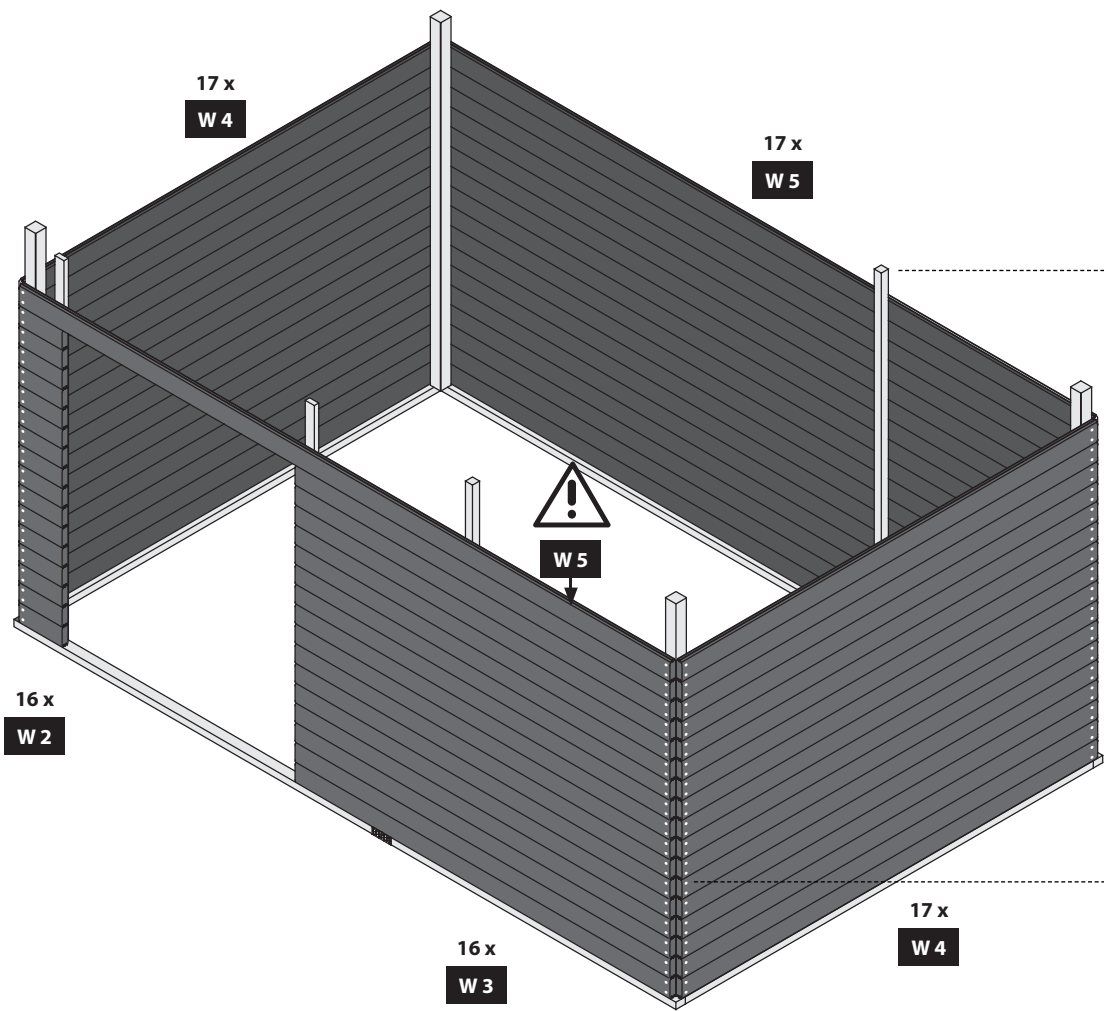

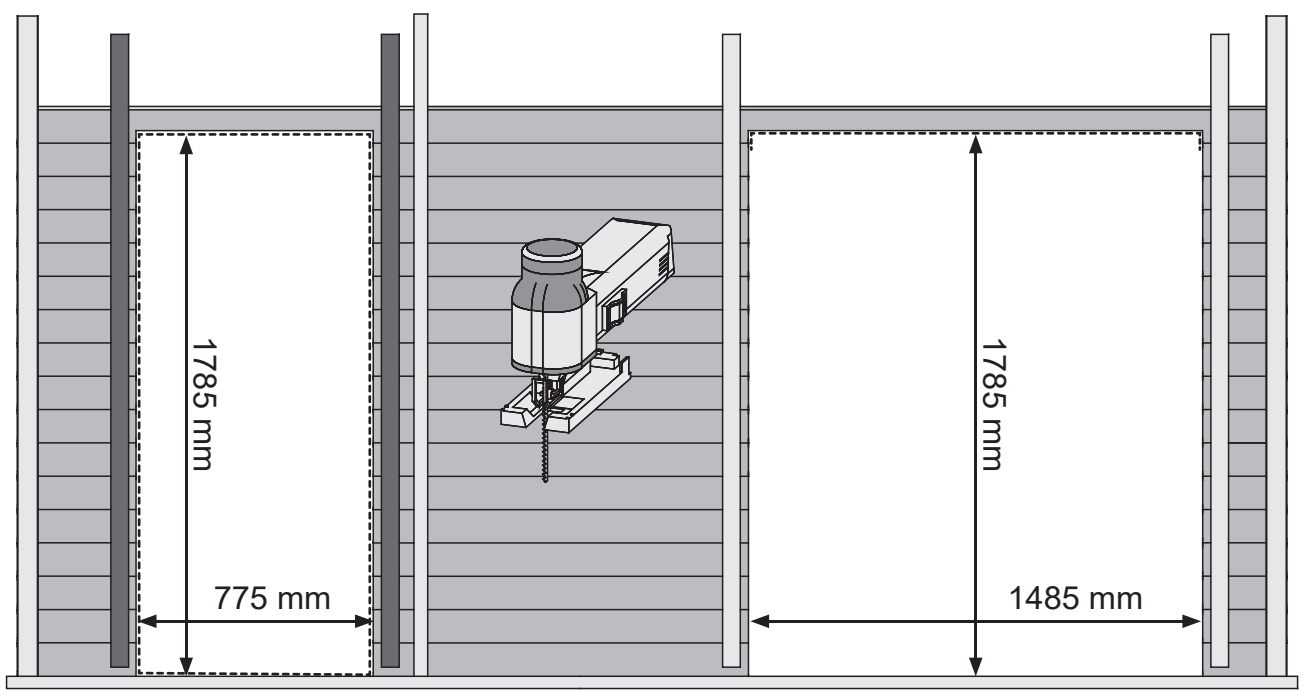
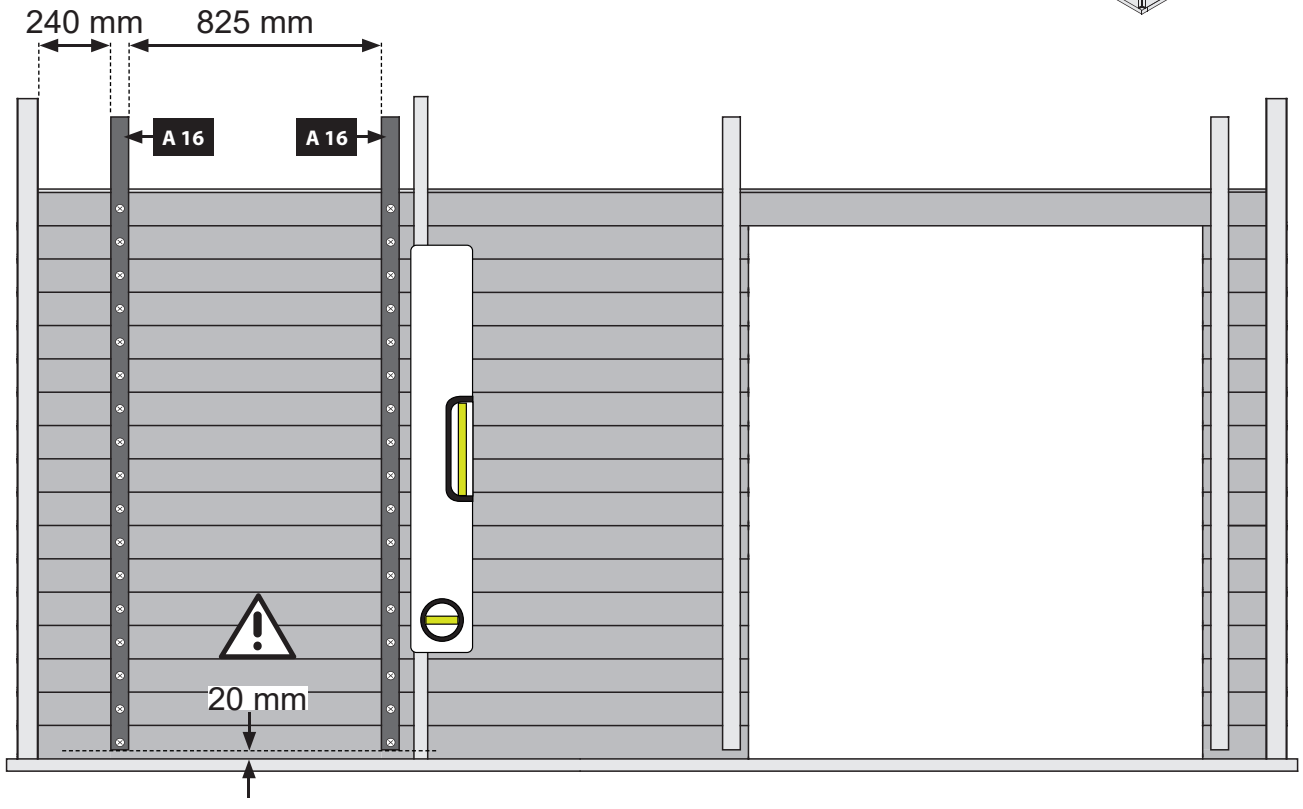
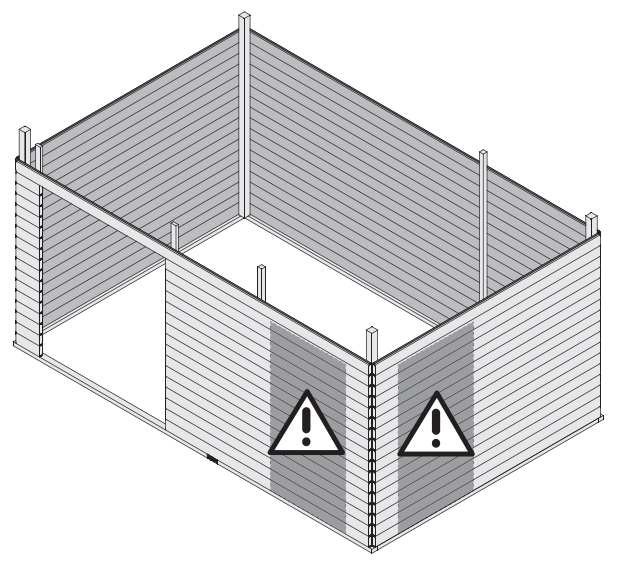
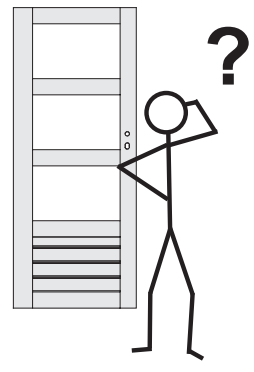
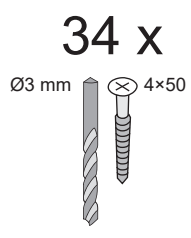

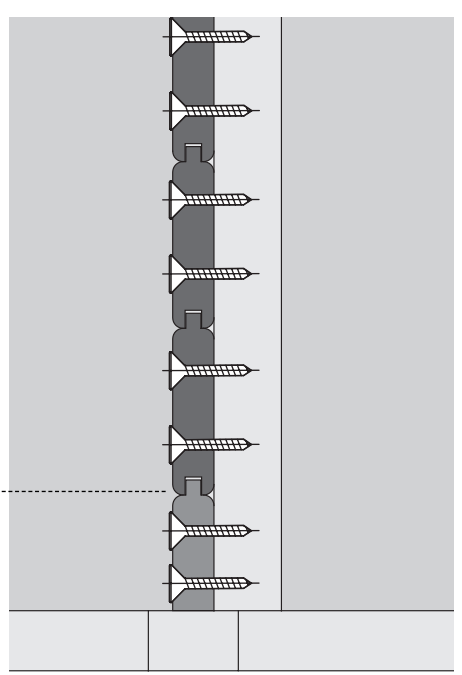
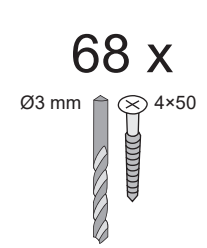
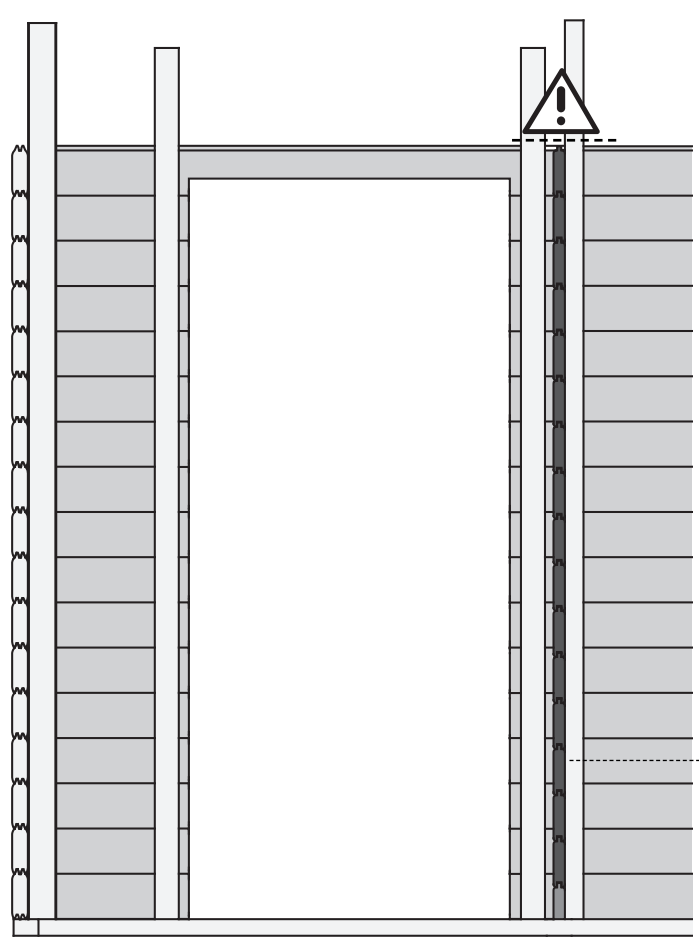
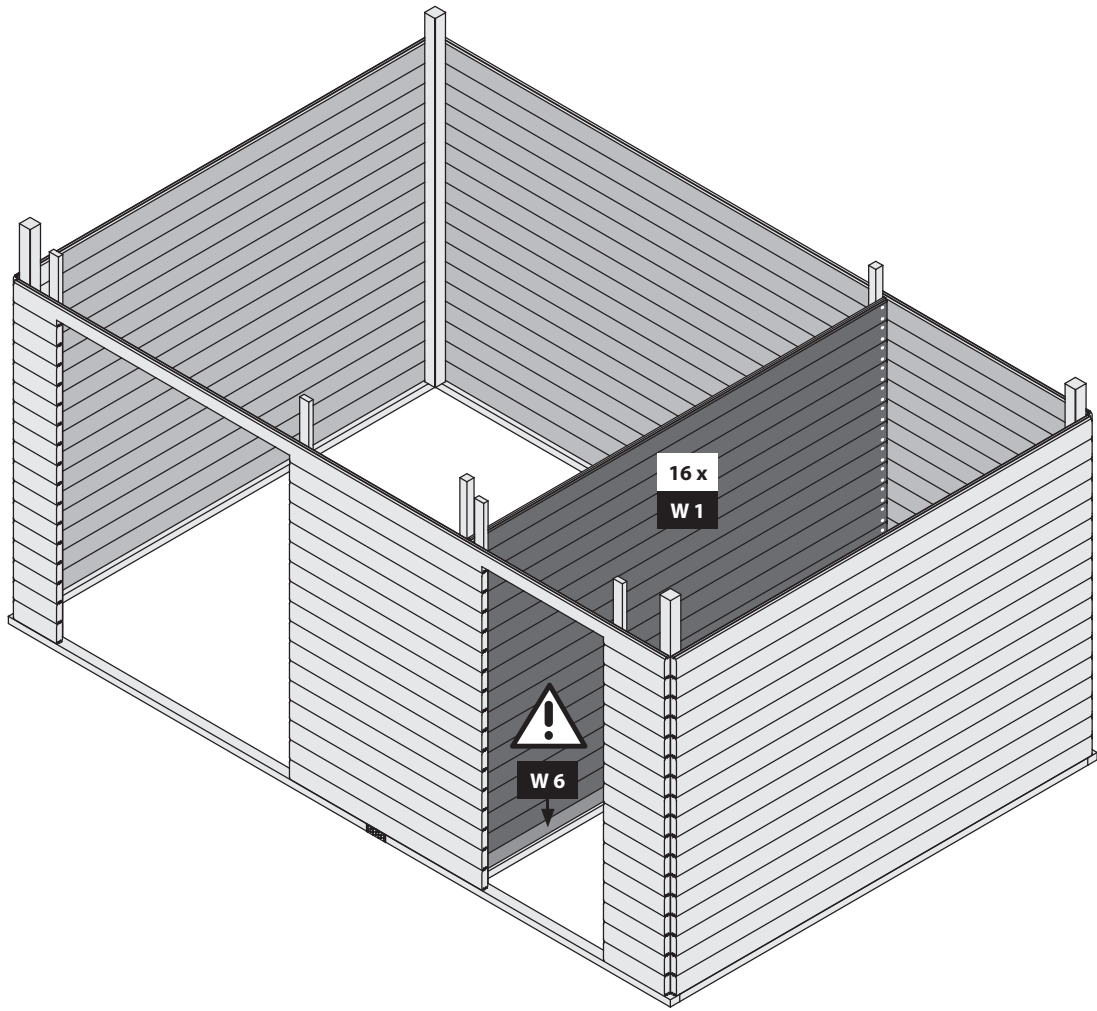

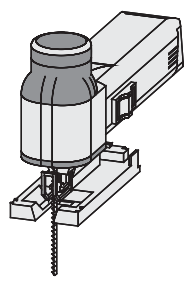
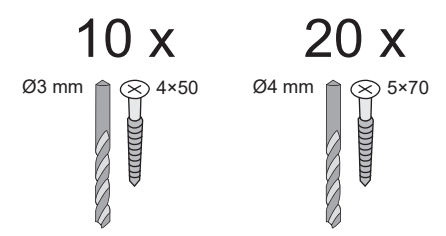
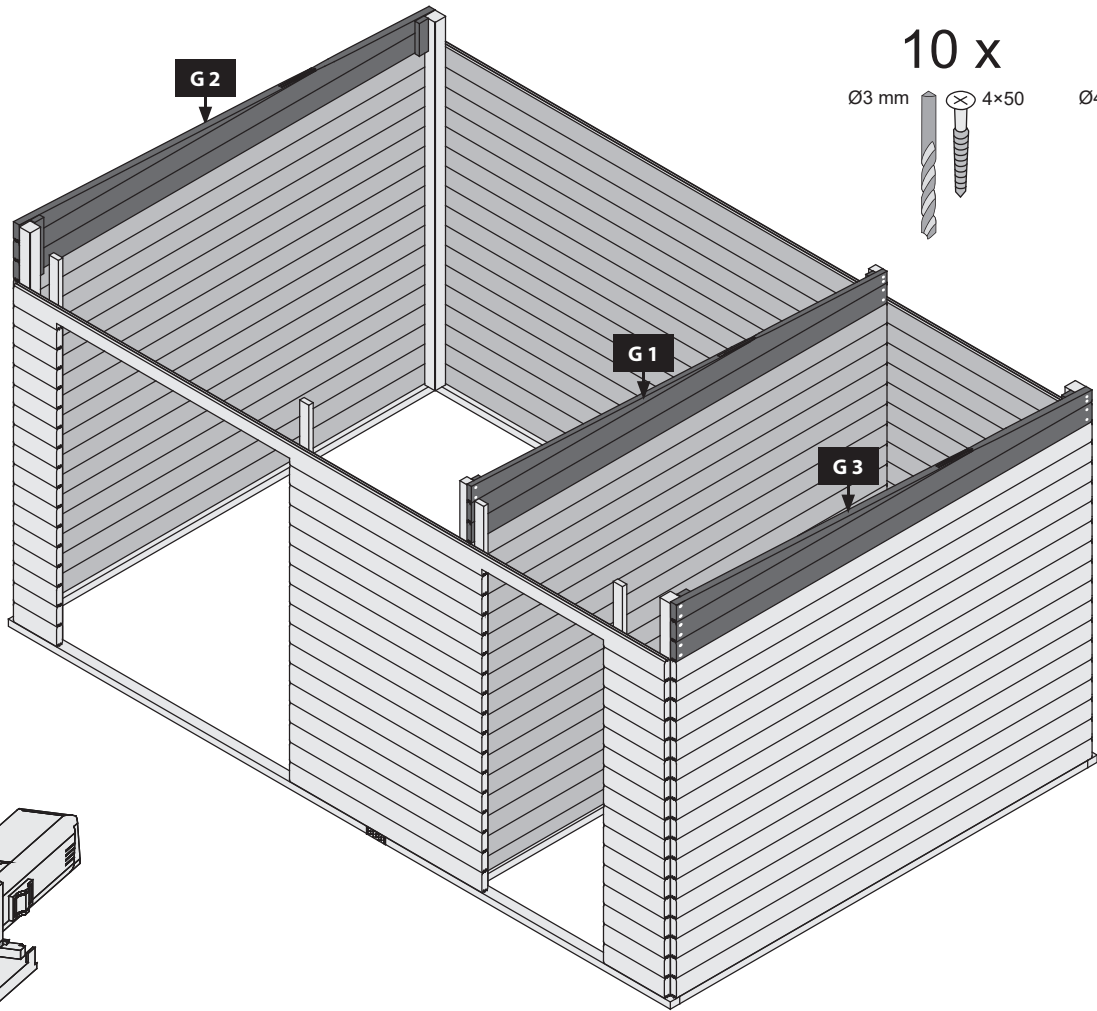

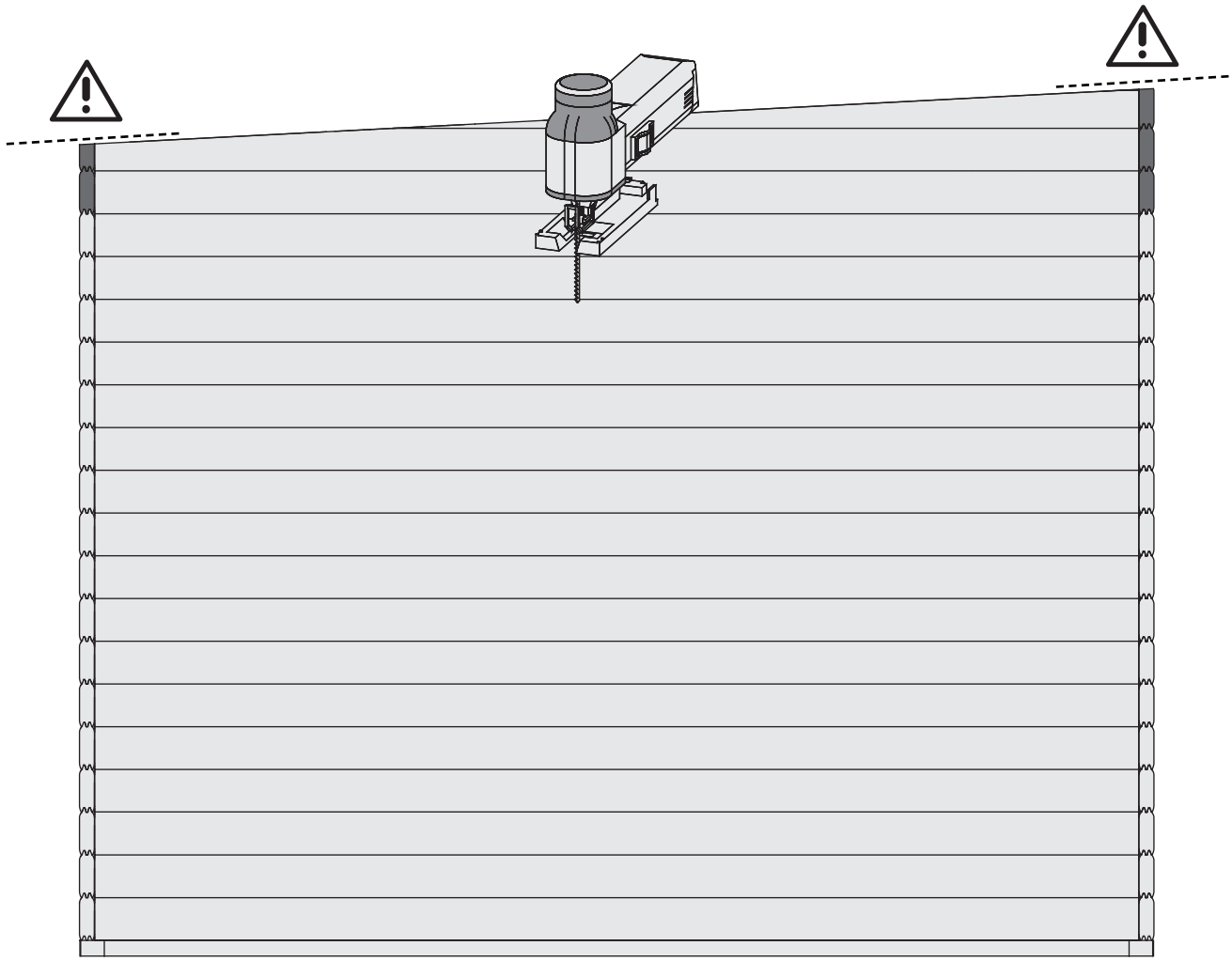
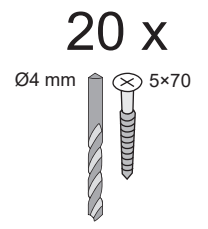
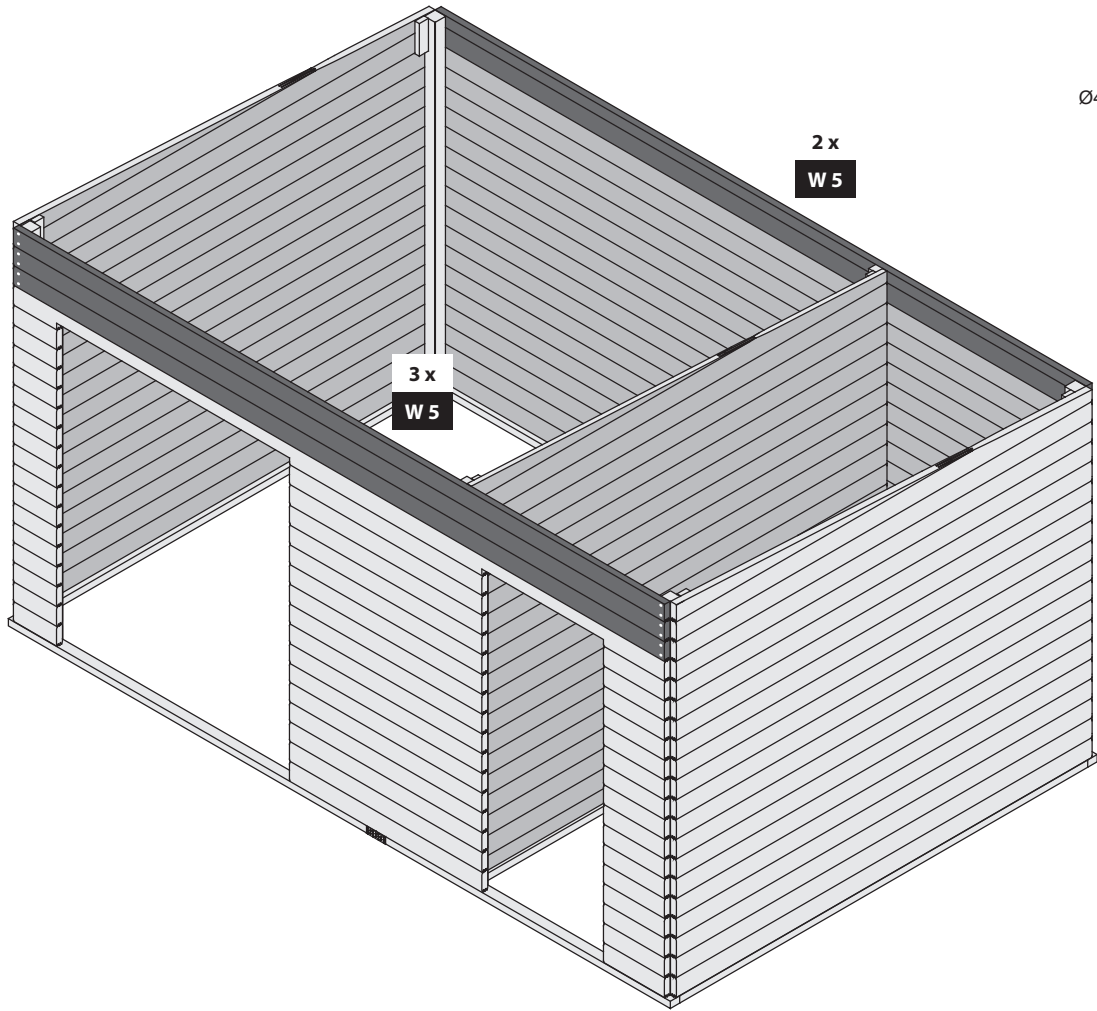

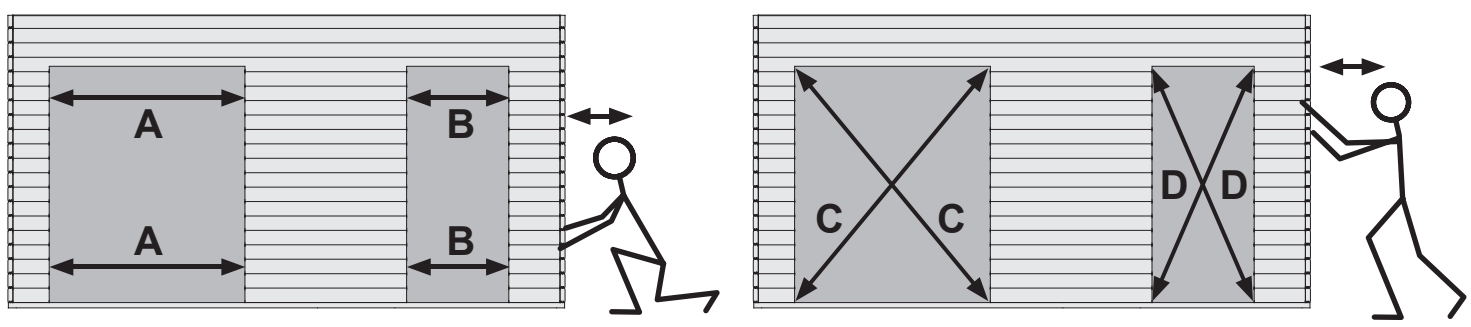

- 4 x A8
- 4 x A9
- 40 x Ø3 mm
- 4x40

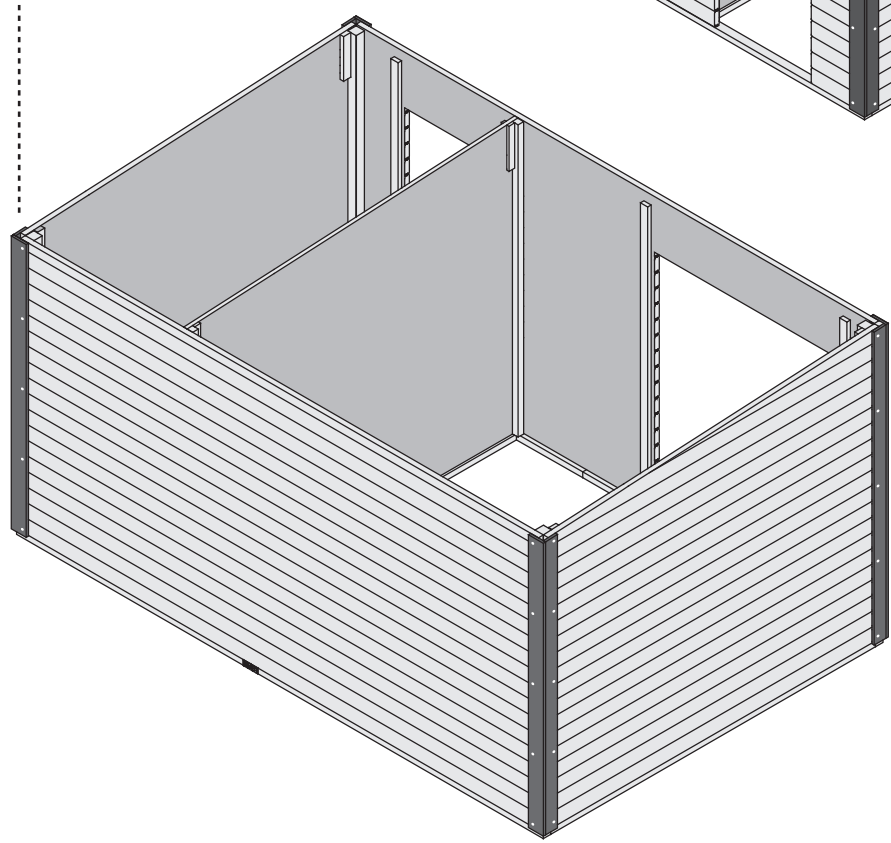
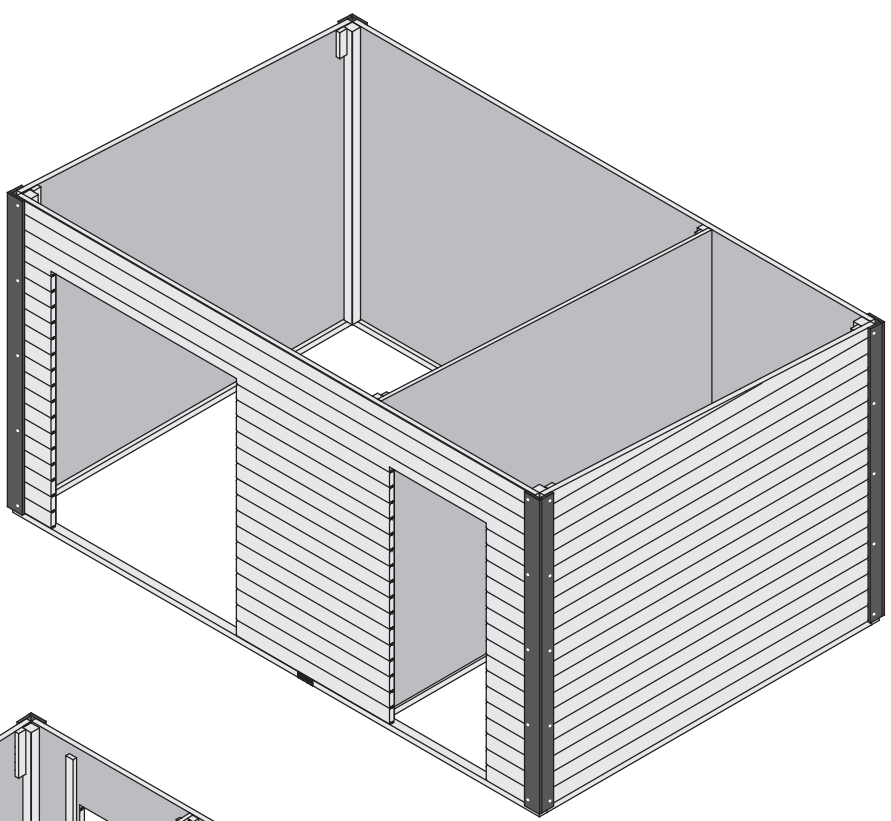
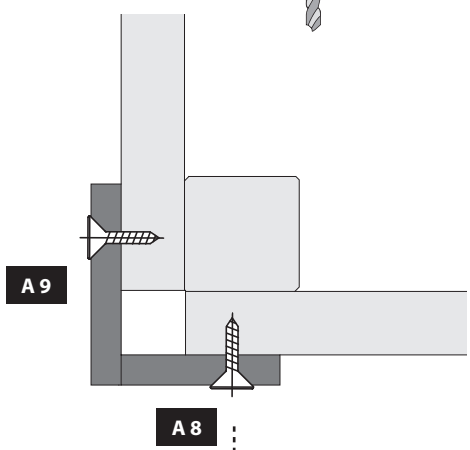

6x

18 x

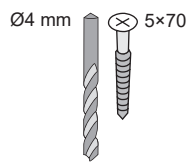

3 x

A 10

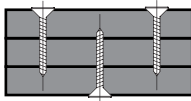
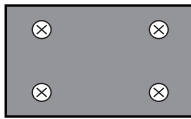

3x

108 x

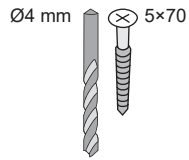

3 x

A 12

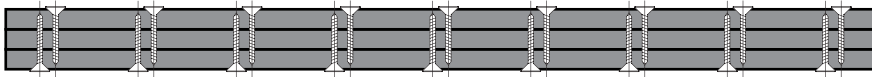

3x

172 x

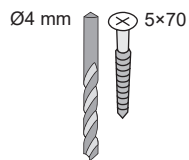

3 x

A 13

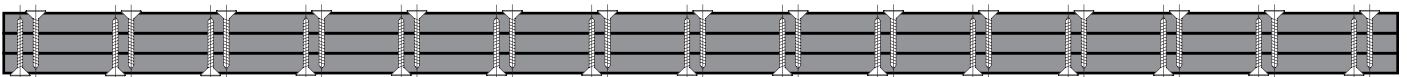
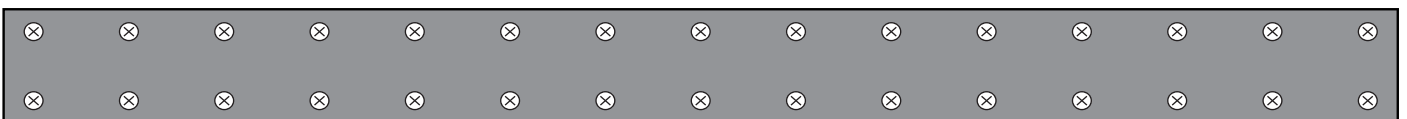





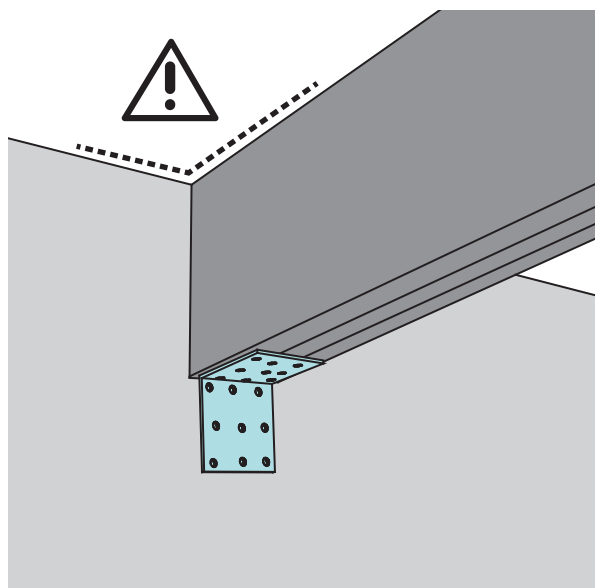
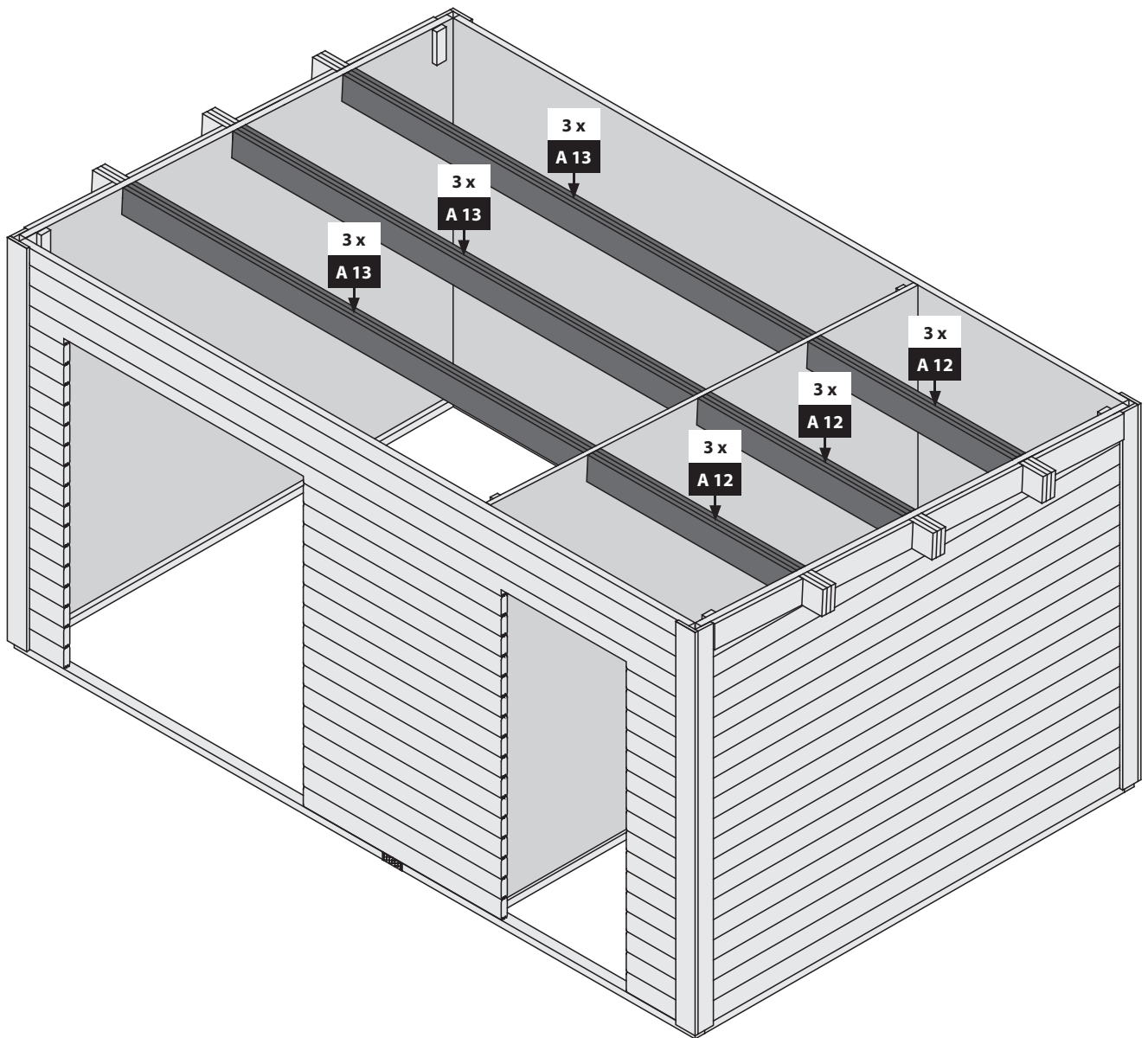

12 x

96 x

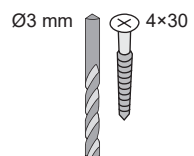
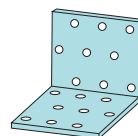

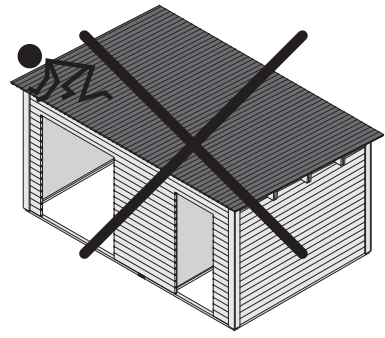
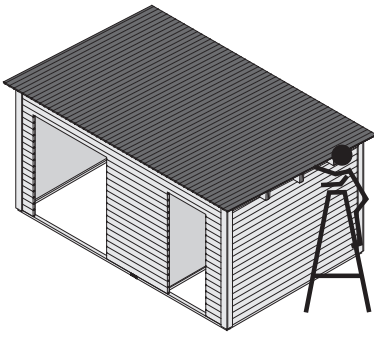

14

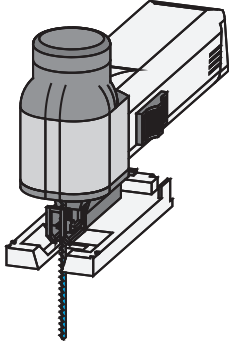

52 x



≈ 520 x

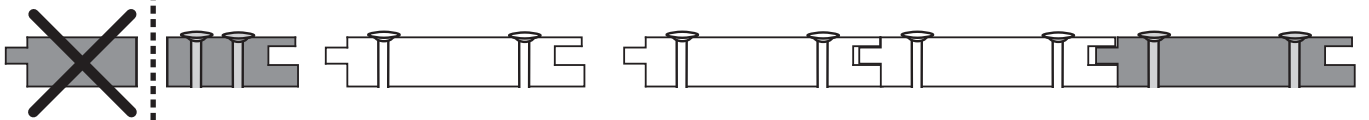
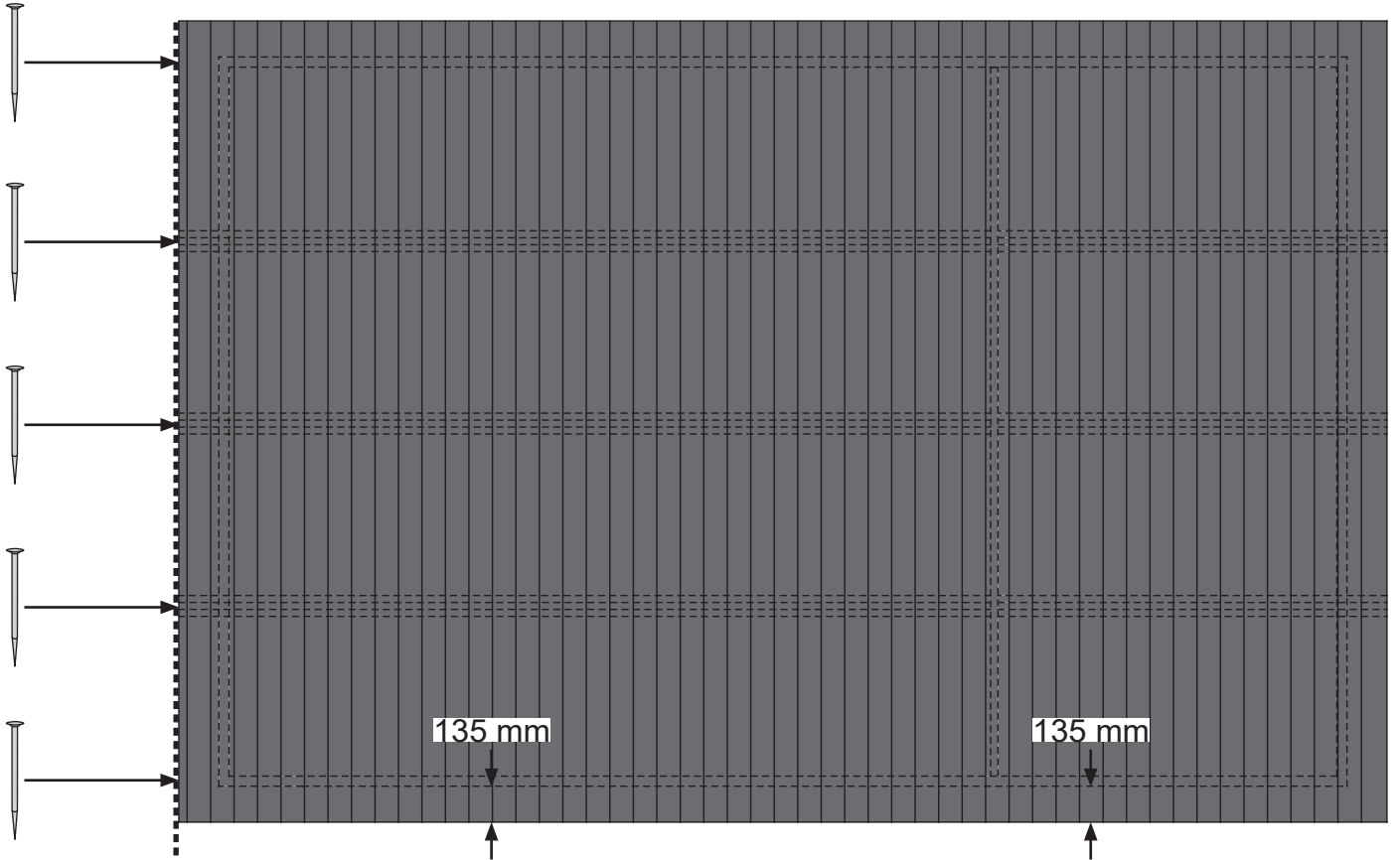

52



1

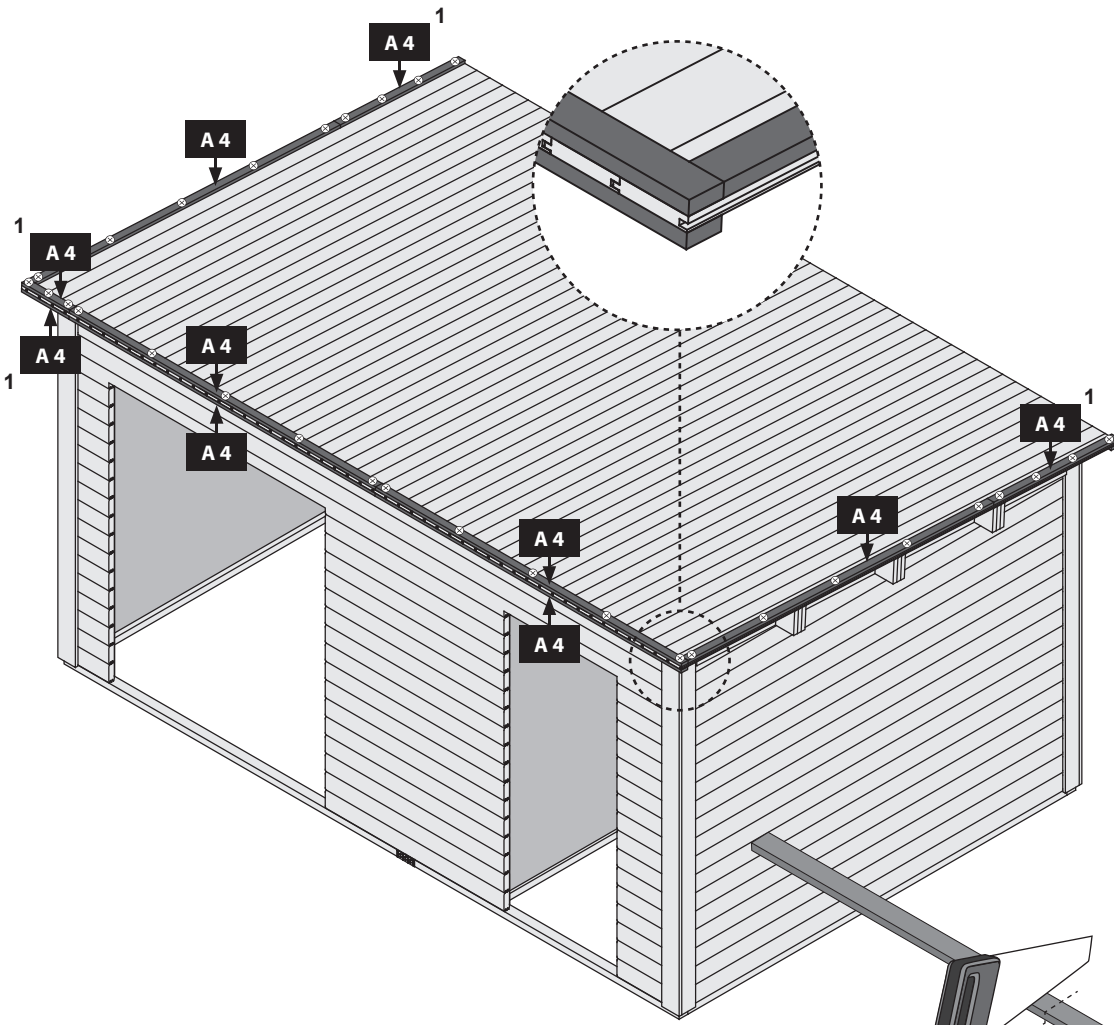

10 x  
A4

44 x

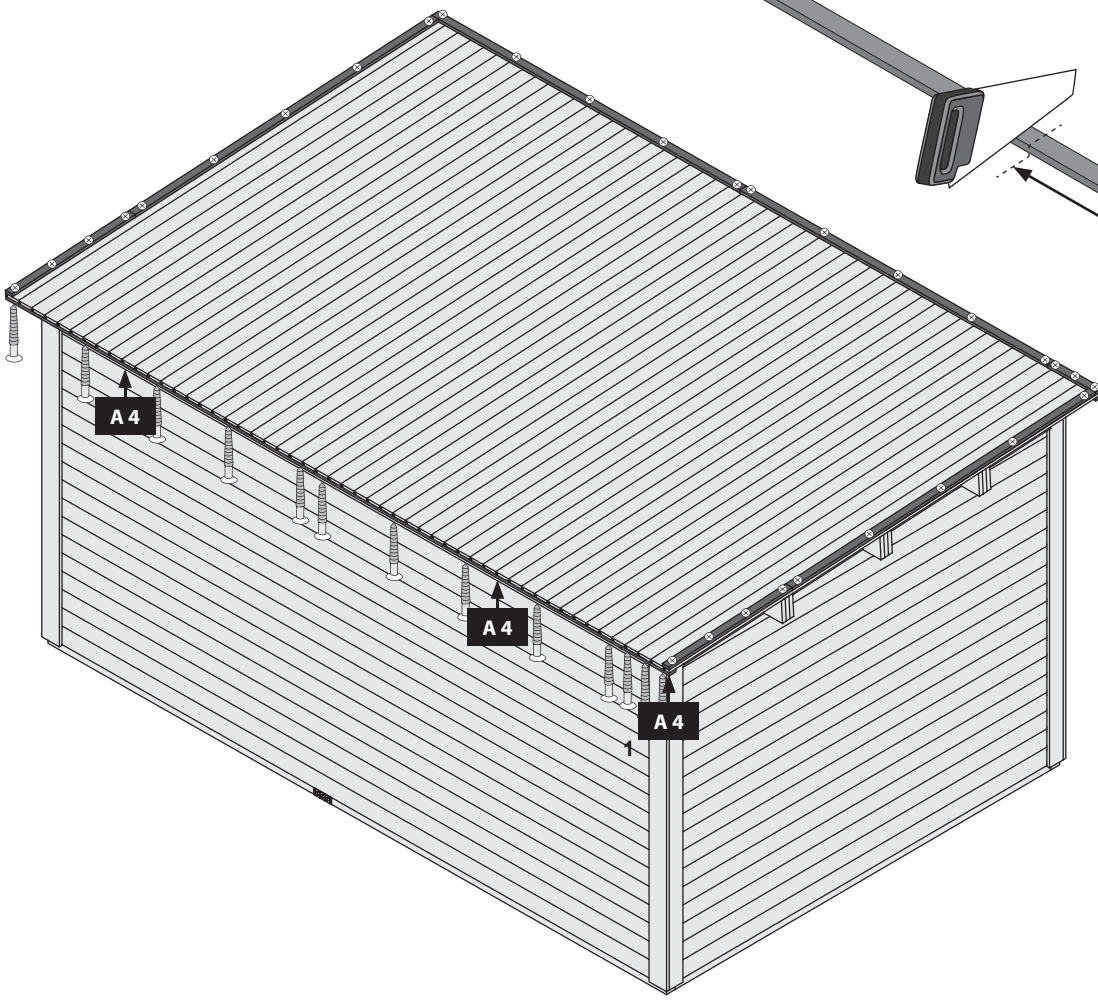
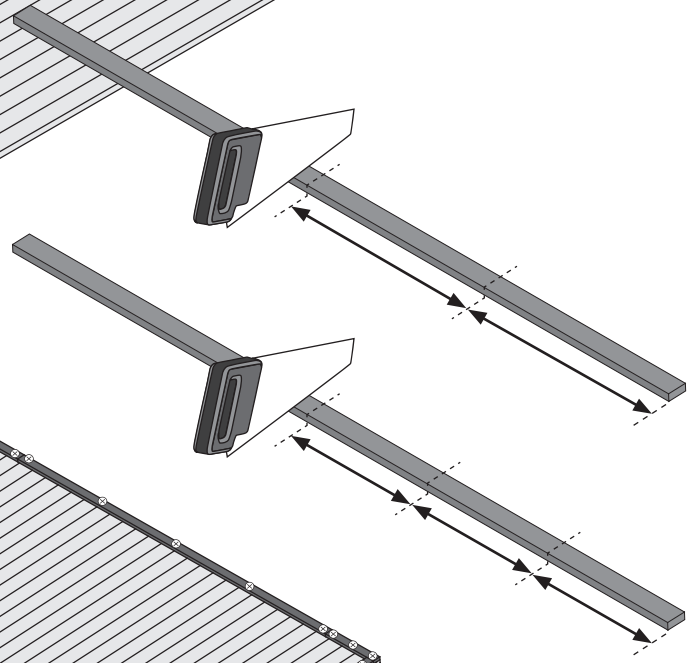
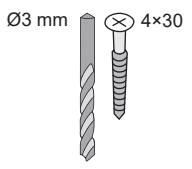

 Montage Bitumendachbelag

 Roofing felt installation

 Montage de toiture en bitume

 Montage dakvilt

 Samling bitumen tagdækning

 Montaje de tela asfáltica

 Copertura bituminosa

 montáž střešní krytiny

 Montáža bitumenske strešne kritine

### **Achtung, dies ist nur ein Verlegebeispiel!**

Die Anzahl der Bahnen richtet sich nach Ihrer Hausgröße. Verbindungen zwischen den Bahnen sind mit einer Überlappung von ca. 10 cm auszuführen. Das Dach ist nicht begehrbar. Die Konstruktion ist für eine Gesamtbelastung (Schnee, Wind) und nicht für eine Punktbelastung ausgelegt. Zur Montage empfehlen wir eine bauseitige Abstützung des Daches von unten. Die Abdichtung der Dachflächen zu angrenzenden Bauteilen mit Bitumendichtmasse ist bauseits zu lösen! Sofern es sich um ein Haus mit Satteldach handelt, sollte bei der Verwendung von Dachschindeln keine Voreindeckung mit Dachpappe vorgenommen werden. Hier sollte lediglich an den beiden Traufseiten ein 20 cm breiter Streifen mit Überstand angebracht werden. Bei Häusern mit einem Tonnendach, verlegen Sie bitte einen Bitumenbelag unter die Schindeln. Bei einem Flachdach ist die Verlegung von Dachschindeln nicht möglich!

### **Note! This description is only an example!**

The number of bitumen strips to be used depends on your actual house size. When joining rolls of roofing felt end to end, the overlap must be approximately 10cm. The roof is not safe to walk on. The roof is designed for a total load (snow, wind) and not for a point load. We recommend you to always support the roof from below during installation. The sealing of the roof surfaces to adjacent components with bitumen sealant has to be effected by the customer! If it is a saddle-roofed house, do not use roofing tiles for roofing. In this case, a 20 cm wide strip of bitumen with overhang should be installed on both sides of the eaves. For houses with a tonne roof, please install a bitumen roofing under the shingles. In the case of a flat roof the laying of roof shingles is not possible!

### **Attention, il s'agit uniquement d'un exemple de pose!**

Le nombre de bandes de bitume utilisés dépend de la dimension de la maison. La jointure des bandes de bitume doit être réalisée avec un chevauchement de 10 cm. Ne pas marcher sur le toit! La construction est appropriée pour une charge totale (neige, vent) et ne pas une charge ponctuelle sur un point précis. Lors du montage, il vous est recommandé de soutenir le toit d'en dessous. L'imperméabilisation des surfaces de toit aux composants adjacents avec un mastic de bitume doit être effectuée par le client! Lorsque vous utilisez des bardeaux pour couvrir une maison avec un toit à deux versants, ne jamais utiliser toiture en bitume ci-dessous. Pour les maisons avec toit en berceau, poser du carton bitumé sous les bardeaux. Pour les maisons de toit plat de la pose de bardeaux de toiture n'est pas possible!

### **Let op, dit is slechts een montagevoorbeeld!**

Het aantal dakviltbanen is afhankelijk van de grootte van uw huis. Verbindingen tussen de stroken uit te voeren met een overlapping van ongeveer 10 cm. Het dak is niet beloopbaar. De constructie is ontworpen voor een totaalbelasting (sneeuw, wind) en niet voor een puntbelasting. Voor de montage adviseren we te voorzien in een zelf aan te brengen steun voor het dak van onderen. De afdichting van de dakoppervlakken van aangrenzende componenten met bitumen afdichtmiddel op te lossen door de klant! Als het gaat om huis met een zadeldak, mag geen Voreindeckung worden gemaakt met dakleer in het gebruik van dakbedekking gordelroos. Hier, moet alleen de twee dakrand zijden een 20cm brede strook dakleer aan te leggen met een overstek. Voor huizen met een dak vat installeer dan een dakleer onder de gordelroos. Met een plat dak leggen shingles is niet mogelijk!

### **Bemærk, dette er kun et monteringskseksempel!**

Antallet af påkrævede ruller af tagbeklædning afhænger af husets faktiske størrelse. Ved sammenføjning af tagdækning ruller ende til ende, skal overlappningen være 10 cm. Når du kun bruger 4 baner af tagpap, skal du altid dække den vandrette kantbjælke med rullerne fra begge sider. Taget er ikke sikkert at gå på. Taget er designet til en total belastning (sne, vind) og ikke for en punktbelastning. Vi anbefaler at du altid støtter taget nedenunder under installationen. Tætningen af tagfladerne til vindbrættet i forenderne skal løses af kunden! Når du bruger tagshingles til at inddække et hus med gavltag, skal du altid bruge underpap tagbeklædningen. Her lægges et 20 cm bredt bånd af tagbeklædning med overlæg på begge sider. Monter altid underpap tagbeklædningen under tagshingles til huse med et buet tag. Ved fladt tag kan tagshingles ikke anvendes!

### **Cuidado, éste es sólo un ejemplo de instalación!**

La cantidad de tiras de tela asfáltica depende del tamaño de su caseta. Las juntas de tela en una tira se realizan solapando la tela asfáltica 10 cm. El techo no es transitable. La construcción está preparada para cargas totales (nieve, viento) y no para cargas puntuales. Para el montaje se recomienda apuntalar el techo por debajo. A menos que haya una casa de techo a dos aguas, sin Voreindeckung debe hacerse con tela asfáltica en el uso de tejas para techos. En este caso, sólo los dos aleros partes deben ser de una amplia franja de 20 cm de tela asfáltica que deben colocarse con un voladizo. Para las casas con el techo abovedado y por favor, instale un techo sintió debajo de las tejas. Con un techo plano por el que las tejas no es posible!

### **Attenzione, questo è solo un esempio di posa!**

La quantità dei rulli di cartone catramato dipende dalle dimensioni della casa. Il concatenamento tra i nastri deve essere effettuata con una sovrapposizione di circa 10 cm. Non salire sul tetto. La costruzione è progettata per un carico diffuso (neve, vento) e non per una concentrazione puntuale del peso. Per il montaggio si consiglia un supporto del tetto con una costruzione posta sotto di esso. Se si dispone di una casa con un tetto a capanna e si desidera utilizzare tegole di copertura, deve essere posato senza fogli di bitume. Qui, un largo 20 cm striscia di bitume deve essere montato esclusivamente ad entrambi i lati della grondaia sporgente 20 cm. Per le case con fogli di bitume per tetti a botte sotto il fuoco di Sant'Antonio da installare. Si prega di non utilizzare il fuoco di Sant'Antonio Dackdeckung con un tetto piatto.

### **Pozor, toto je jen příklad, kterým!**

Počet Dachpappbahnen závisí na velikosti domu. Spojení mezi asfaltem pásu má být provedena s přesahem asi 10 cm. Při použití pouze čtyři běhy ne Firstbahn použití, boční panely s ležel přes hřeben. Střecha není přístupný. Konstrukce je (sníh, vítr) a není určen pro bodové zatížení na celkové zatížení. Pro montáž doporučujeme znovu podporu na místě střechy zespodu. Utěsnění střešních oblastí do podhledů na čelních plochách je na místě řešit! Máte-li dům se sedlovou střechou, je třeba žádné Asfaltové pásy umístěny pod šindele. Zde je 20 cm široký pás střešní plst' je pouze na obou stranách okapového se supernatantem odloženou. Pro rodinné domy s valenou střechou prosím ležel lepenkový pod šindelem. Pro ploché střechy domů pokládka střešních šindelů není možné!

### **Pozor, to je le primer namestitve!**

Priložena bitumenska strešna kritina je namenjena začetnemu prekrivanju in jo je treba po dveh mesecih dopolniti z lastnim izdelkom. Število listov je odvisno od velikosti vaše hiše. Stiki med ploščami morajo biti izvedeni s prekrivanjem približno 10 cm. Po strehi se ne sme hoditi. Konstrukcija je zasnovana za splošno obremenitev (sneg, veter) in ne za točkovno obremenitev. Pri montaži priporočamo, da streho od spodaj podpre stranka. Tesnjenje strešnih površin s sosednjimi gradbenimi elementi z bitumensko tesnilno maso mora rešiti stranka! Če gre za hišo z dvokapno streho, pri uporabi strešnikov ni treba izvesti predhodnega prekrivanja s strešno lepenko. V tem primeru je treba na obeh straneh ostrišja uporabiti le 20 cm širok pas s previsom. Pri hišah s sodasto streho pod skode položite bitumensko prevleko. Na ravno streho ni mogoče položiti skodel!

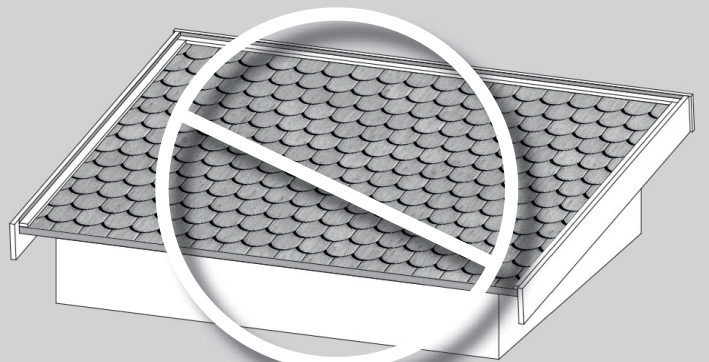
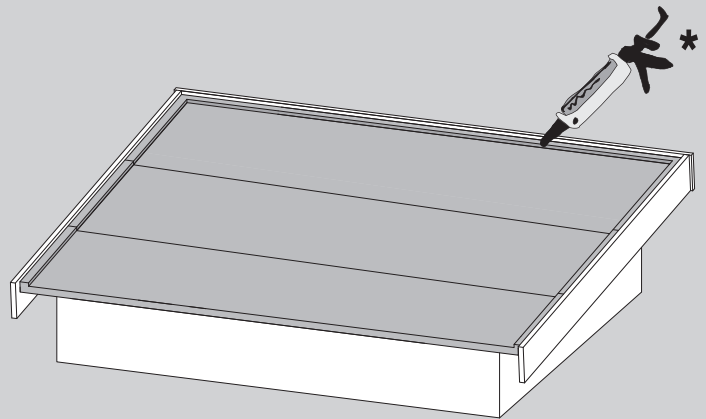
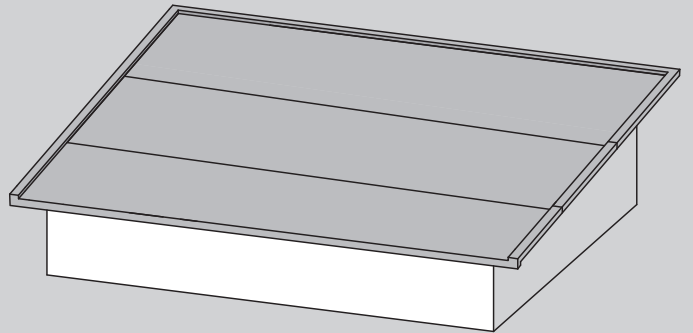
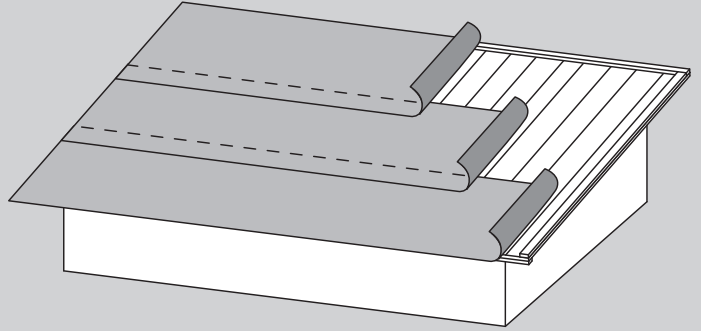
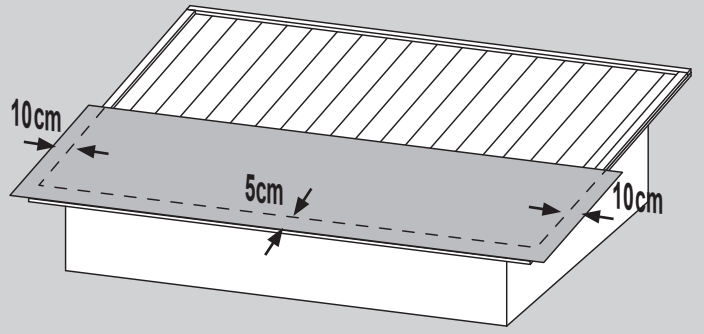
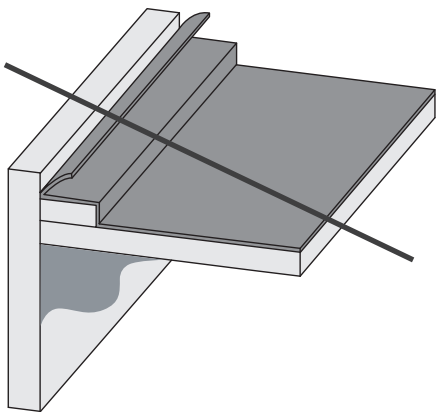
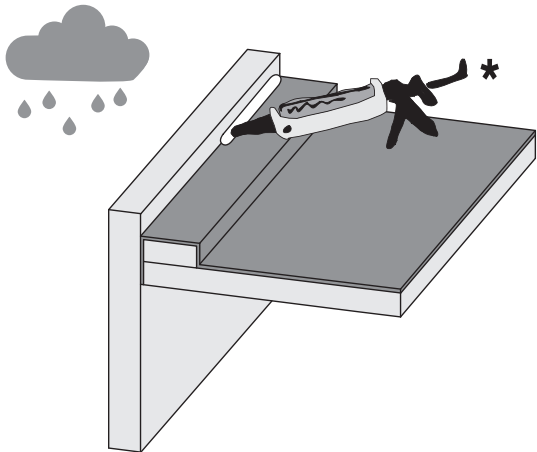
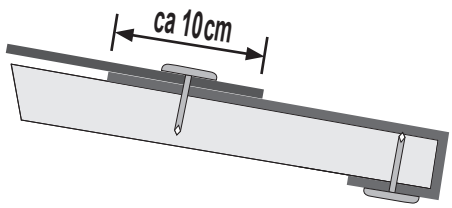
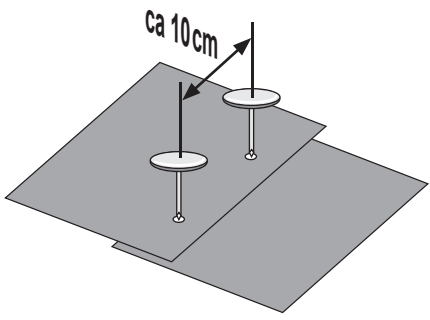

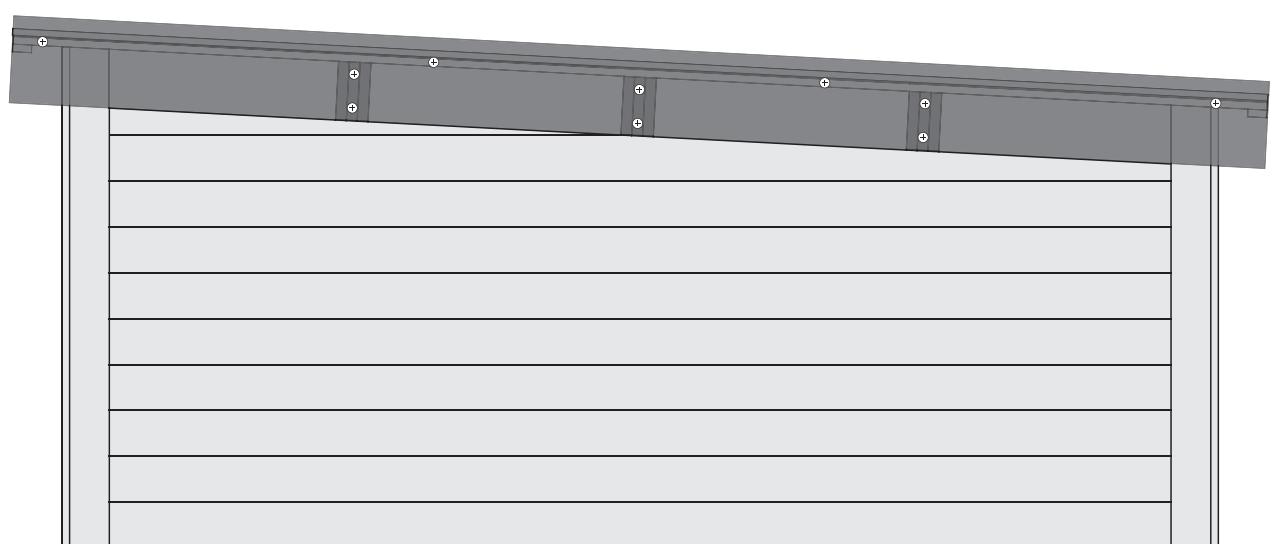
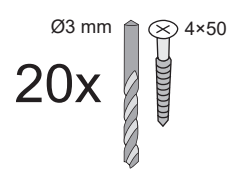
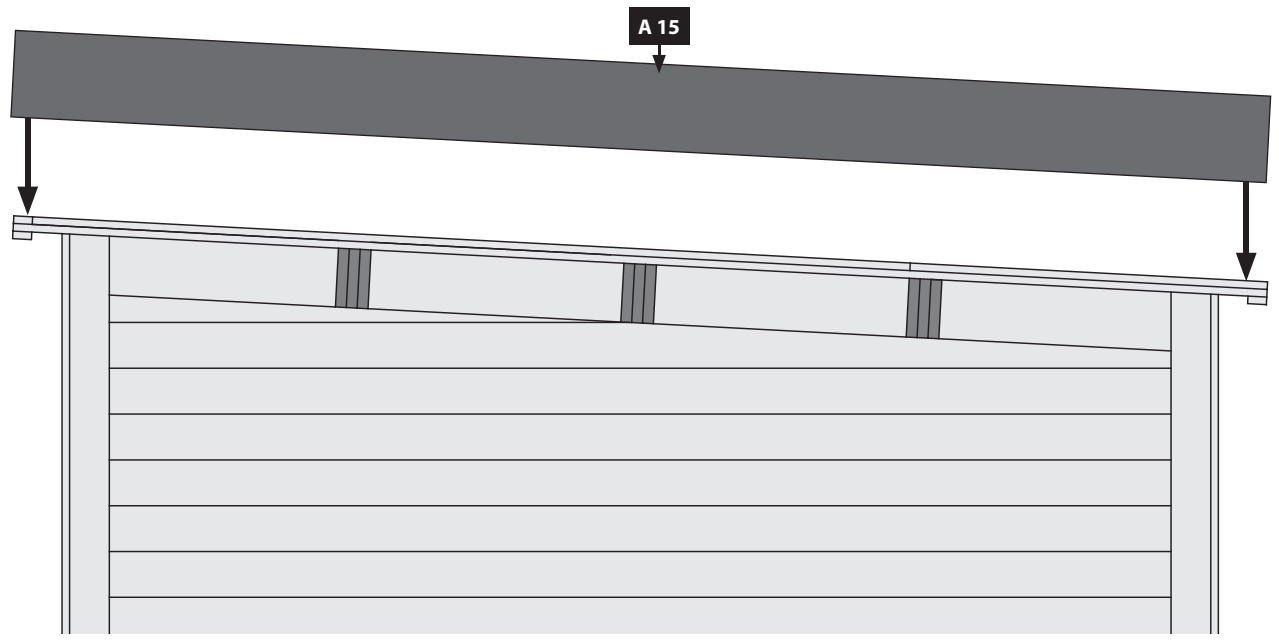
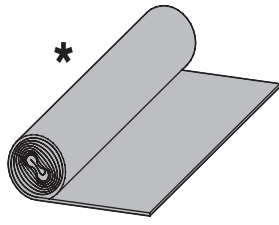

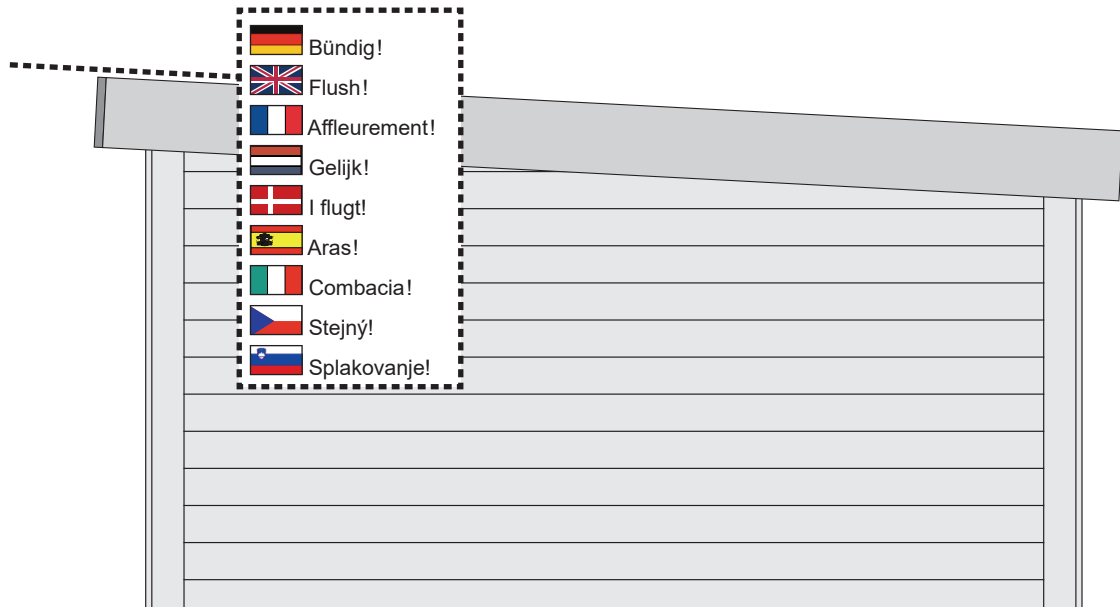
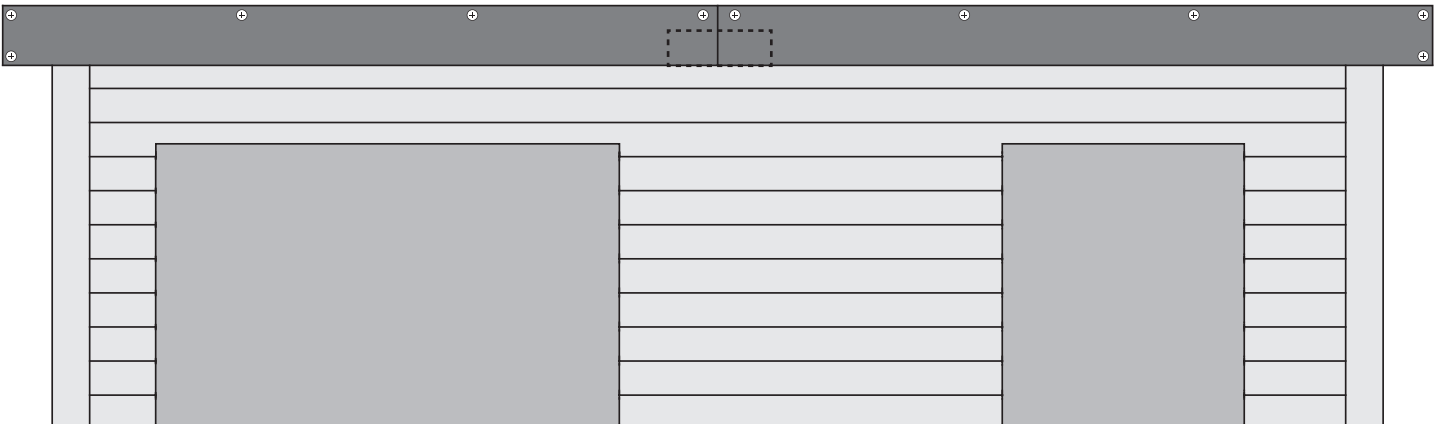
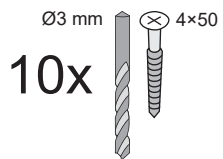
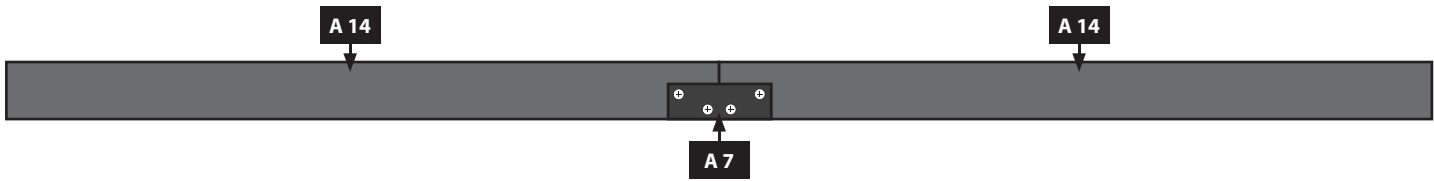
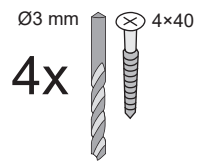

Legend for installation types:









-  Bündig!
-  Flush!
-  Affleurement!
-  Gelijk!
-  I flugt!
-  Aras!
-  Combacia!
-  Stejný!
-  Splakovanje!







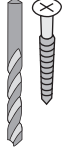
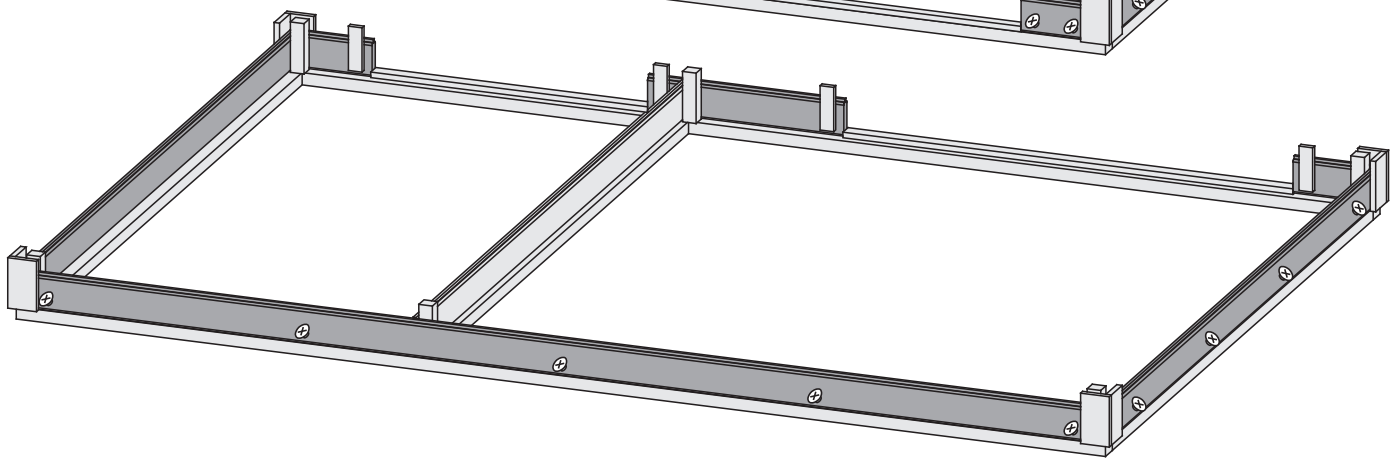
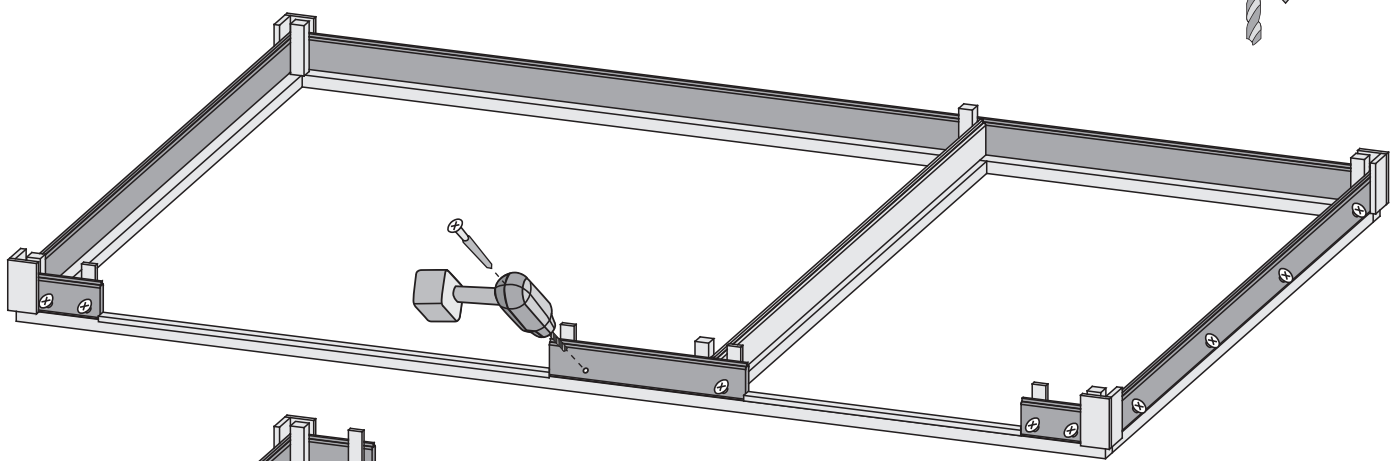

Diagram showing a slatted structure with a top beam and vertical supports.



Ø3 mm 4x50  
20x 



**\***

-  Nicht im Lieferumfang enthalten
-  Not included
-  Non comprises dans la livraison
-  Niet bijgeleverd
-  No forman parte del suministro
-  Non incluso
-  V ceně není zahrnuto
-  Ikke inkluderet

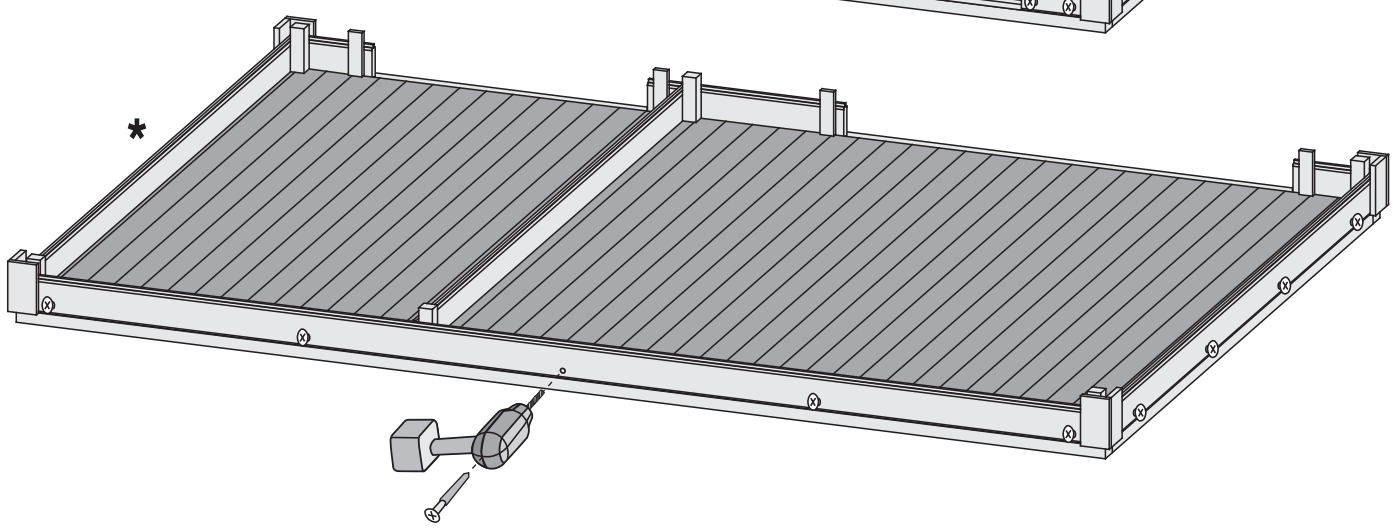
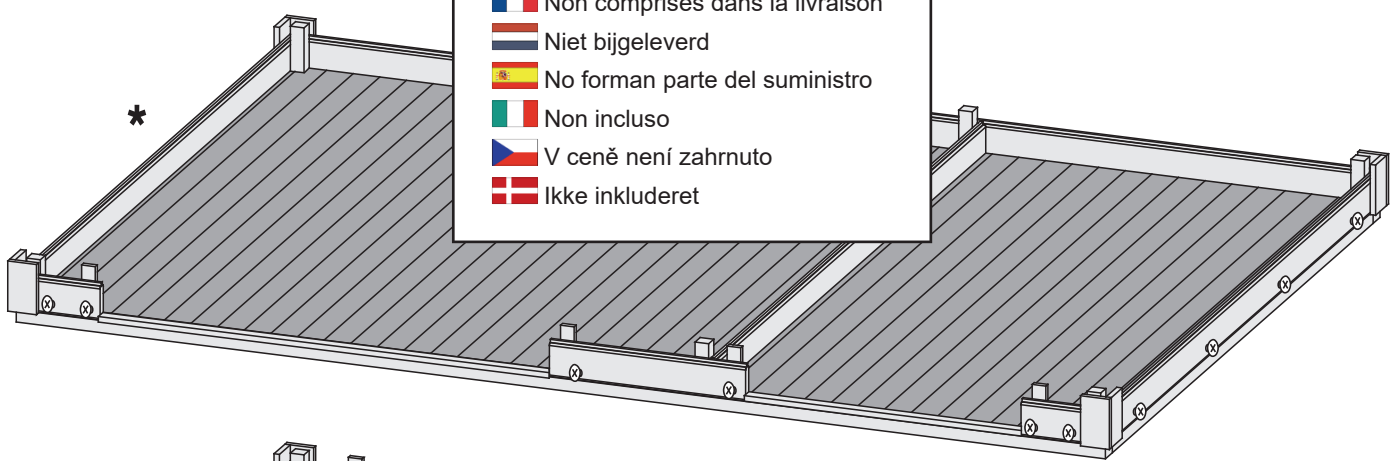



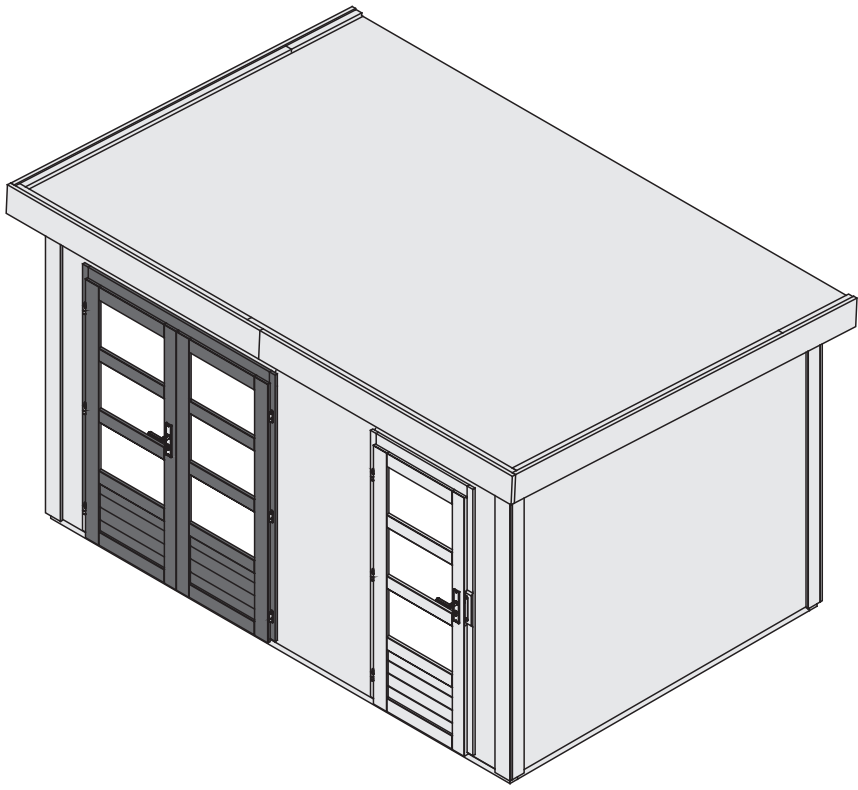

-  Bündig!
-  Flush!
-  Affleurement!
-  Gelijk!
-  I flugt!
-  Aras!
-  Combacia!
-  Stejný!
-  Splakovanje!

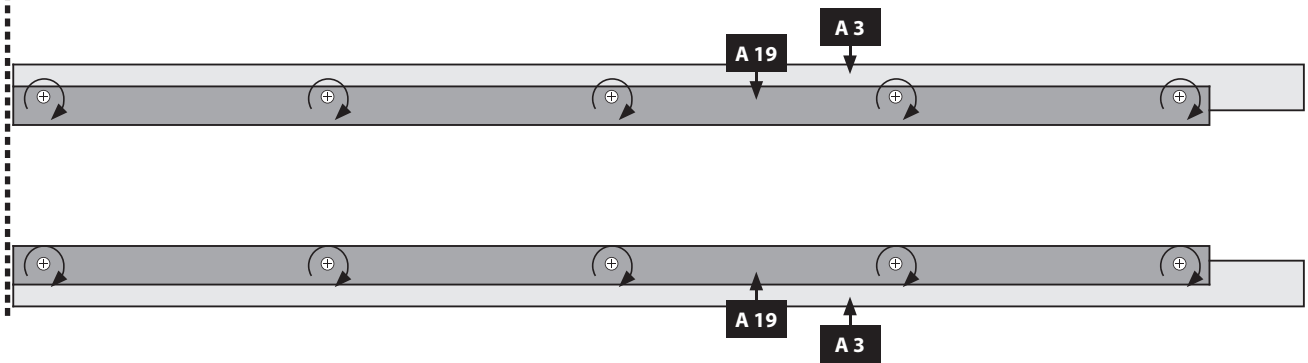
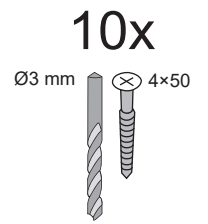
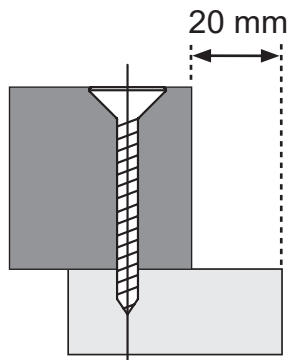



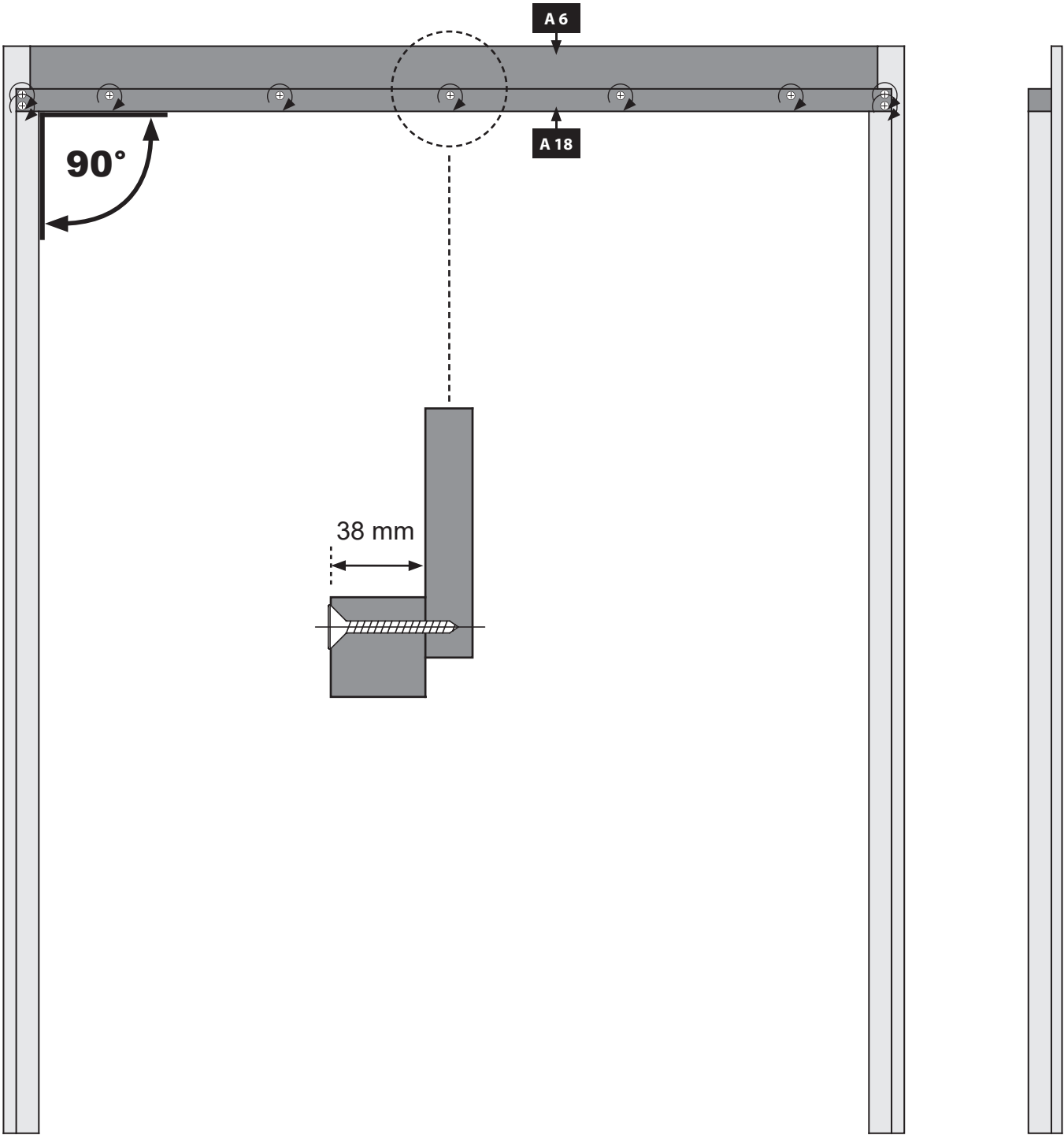
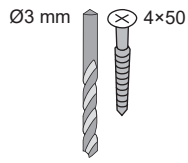

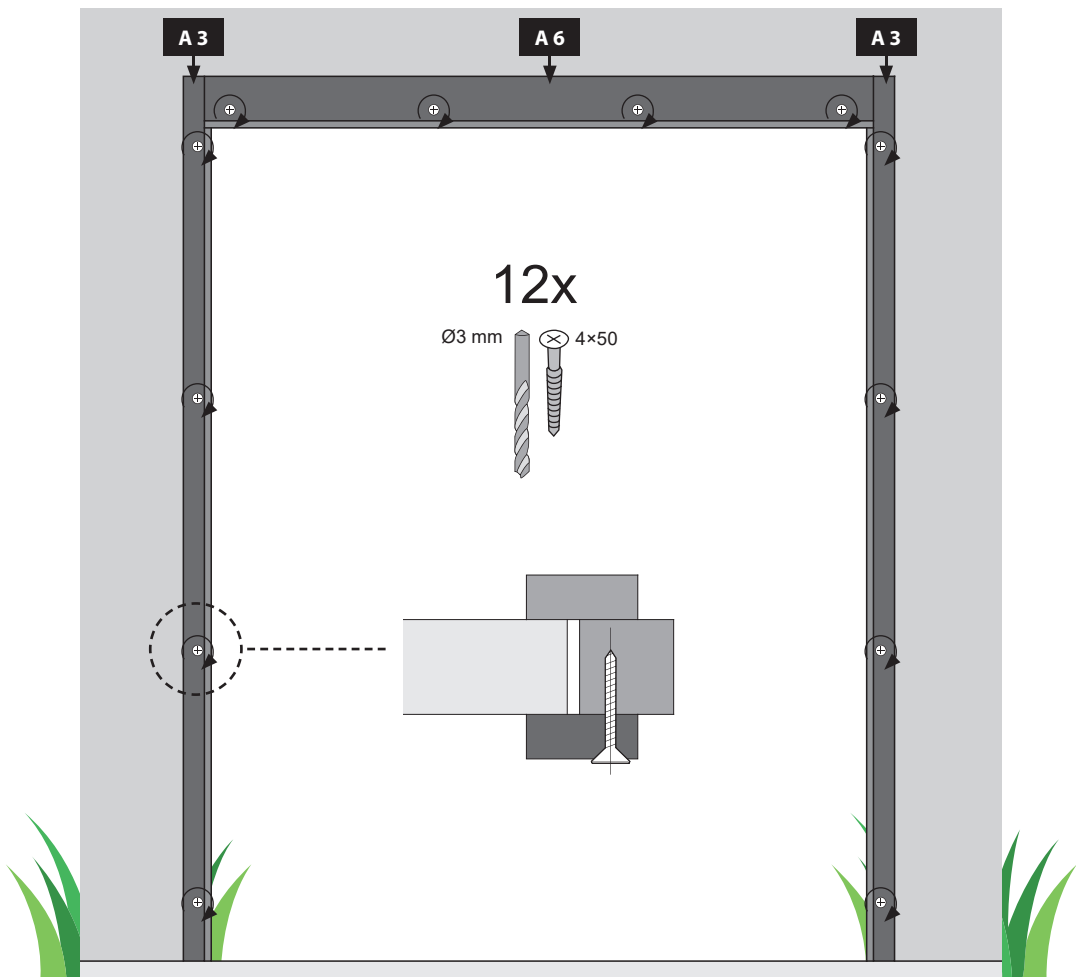
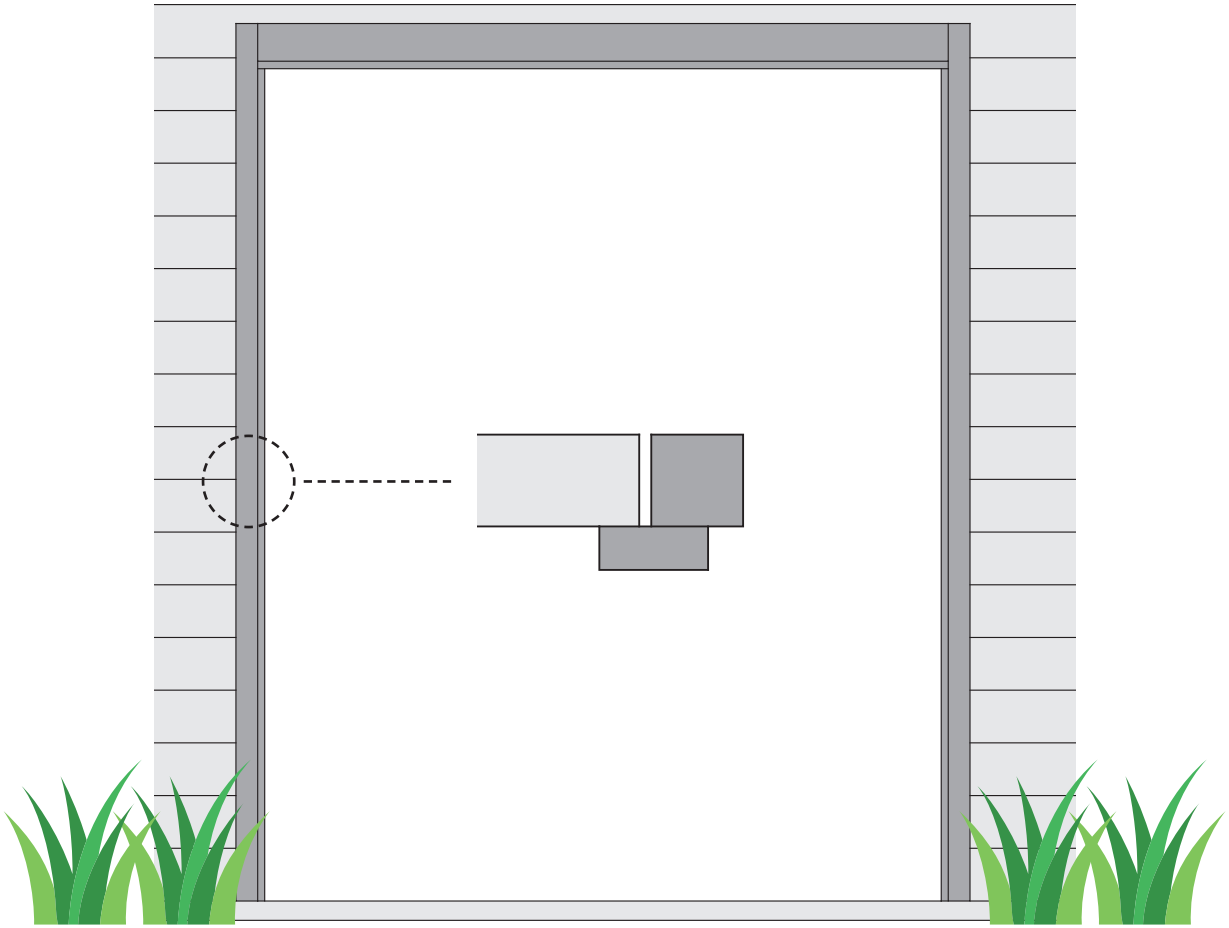

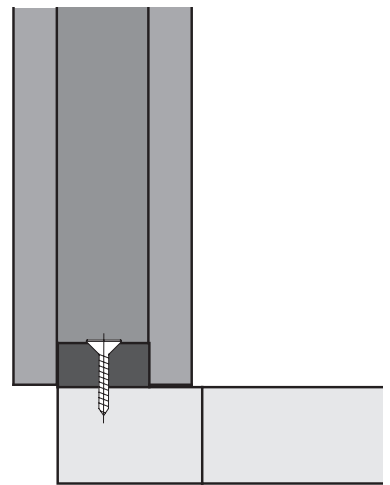
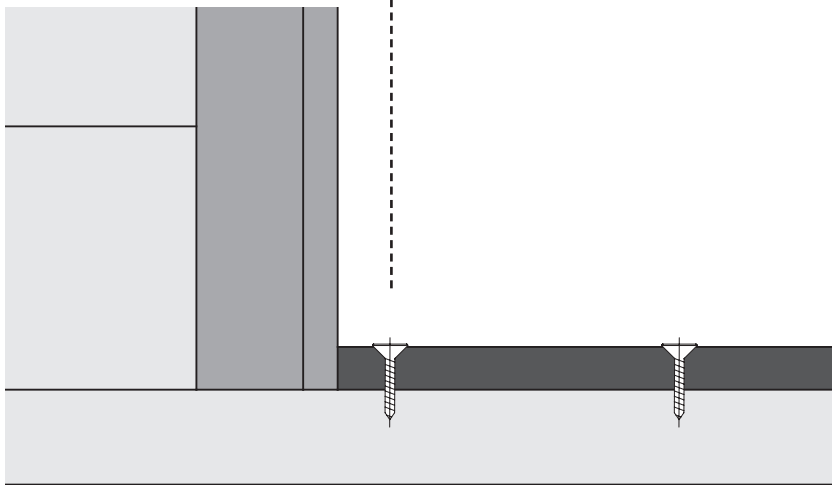
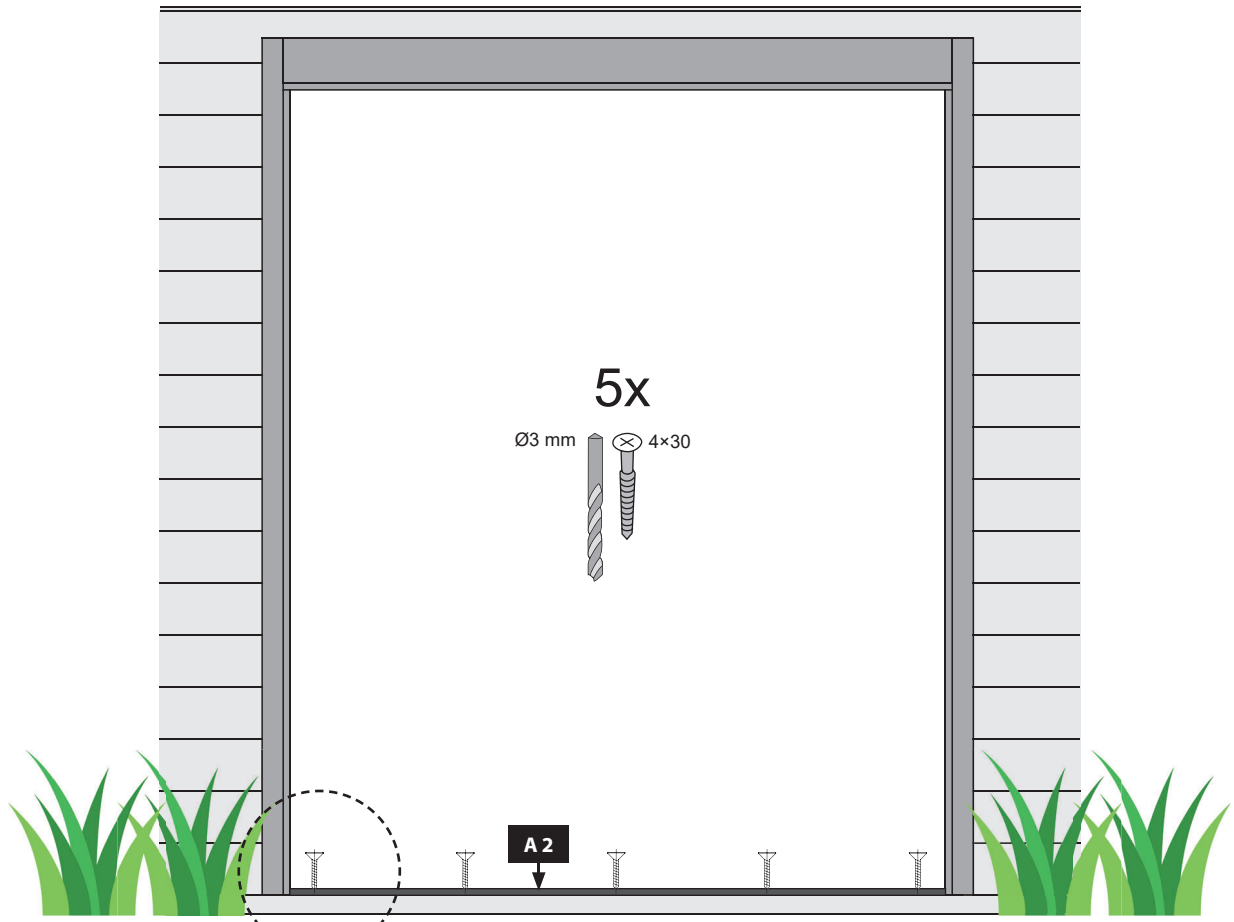

9x







- |  |   |   |
|--|---|---|
|  Schutzfolie abziehen        |  Verwijder de beschermende film |  Rimuovere la pellicola protettiv |
|  Remove protective film     |  Fjern beskyttelsesfilm        |  Odstraňte ochranný film         |
|  Retirer le film protecteur |  Retire la película protector  |  Odstranite zaščitno folijo      |

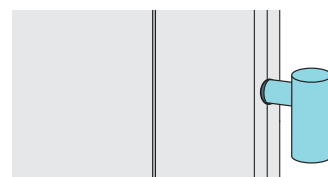
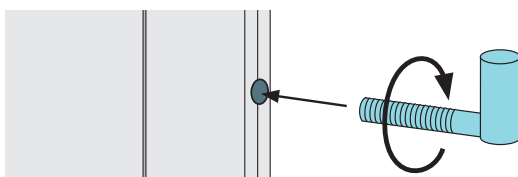
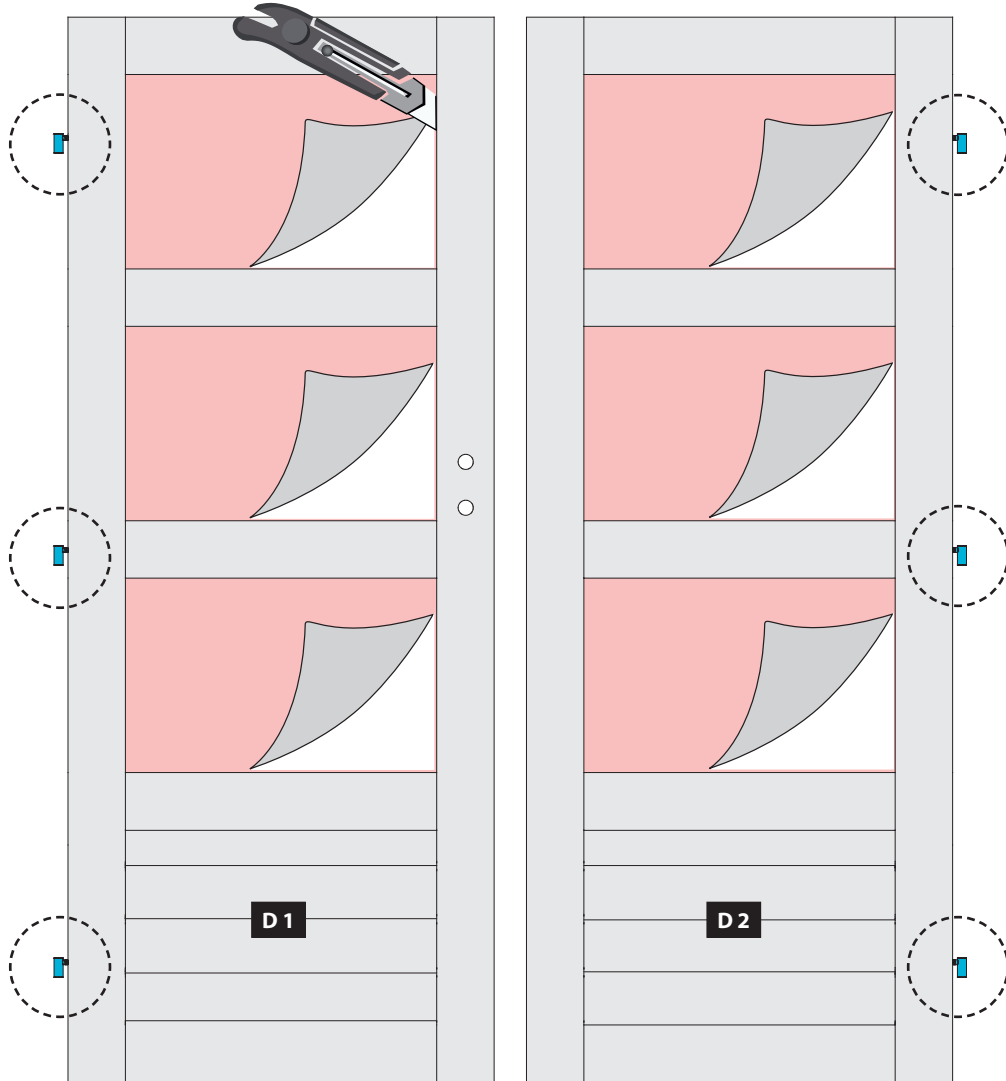

18x

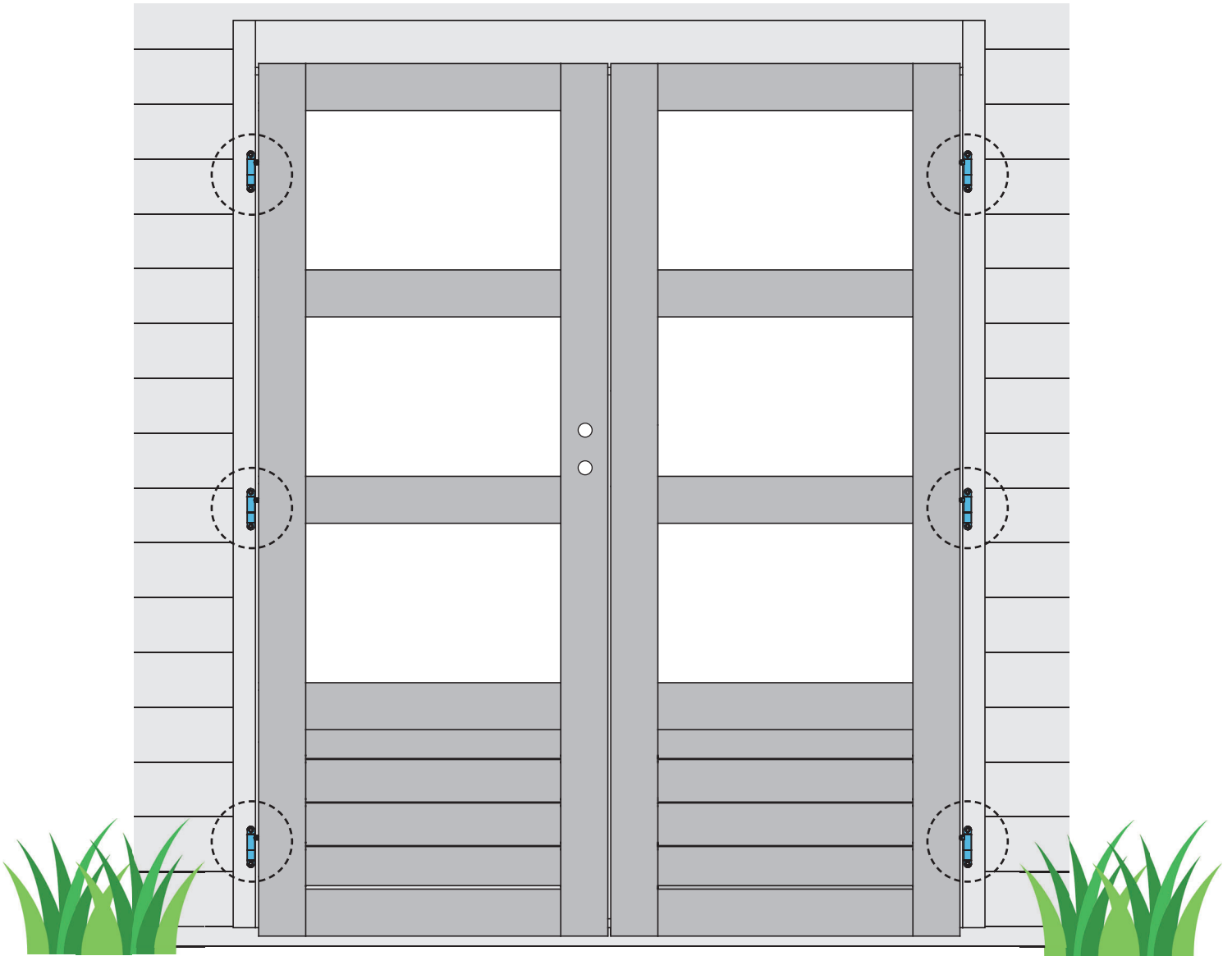
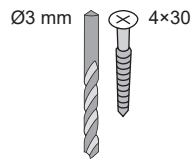

1.

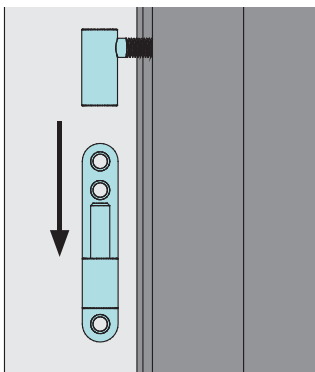

2.

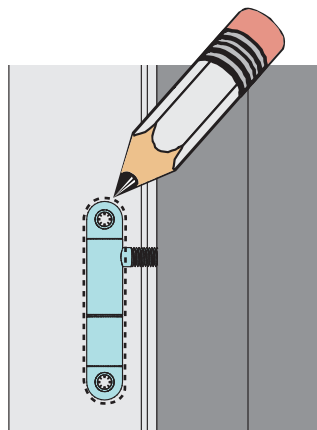

3.

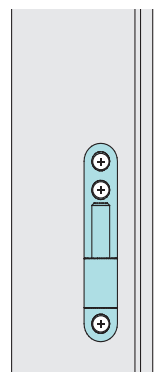

5x

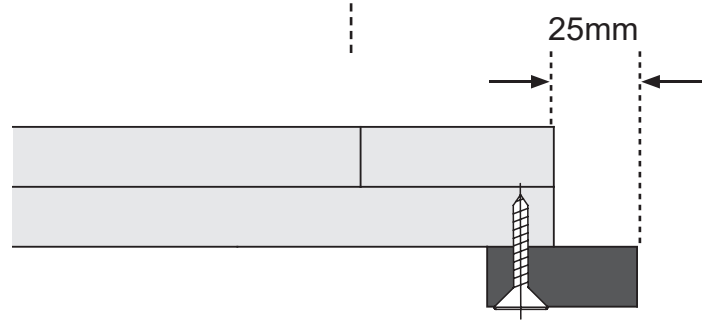
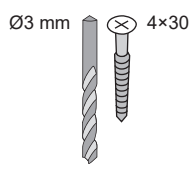

8x

Ø3 mm 4x18

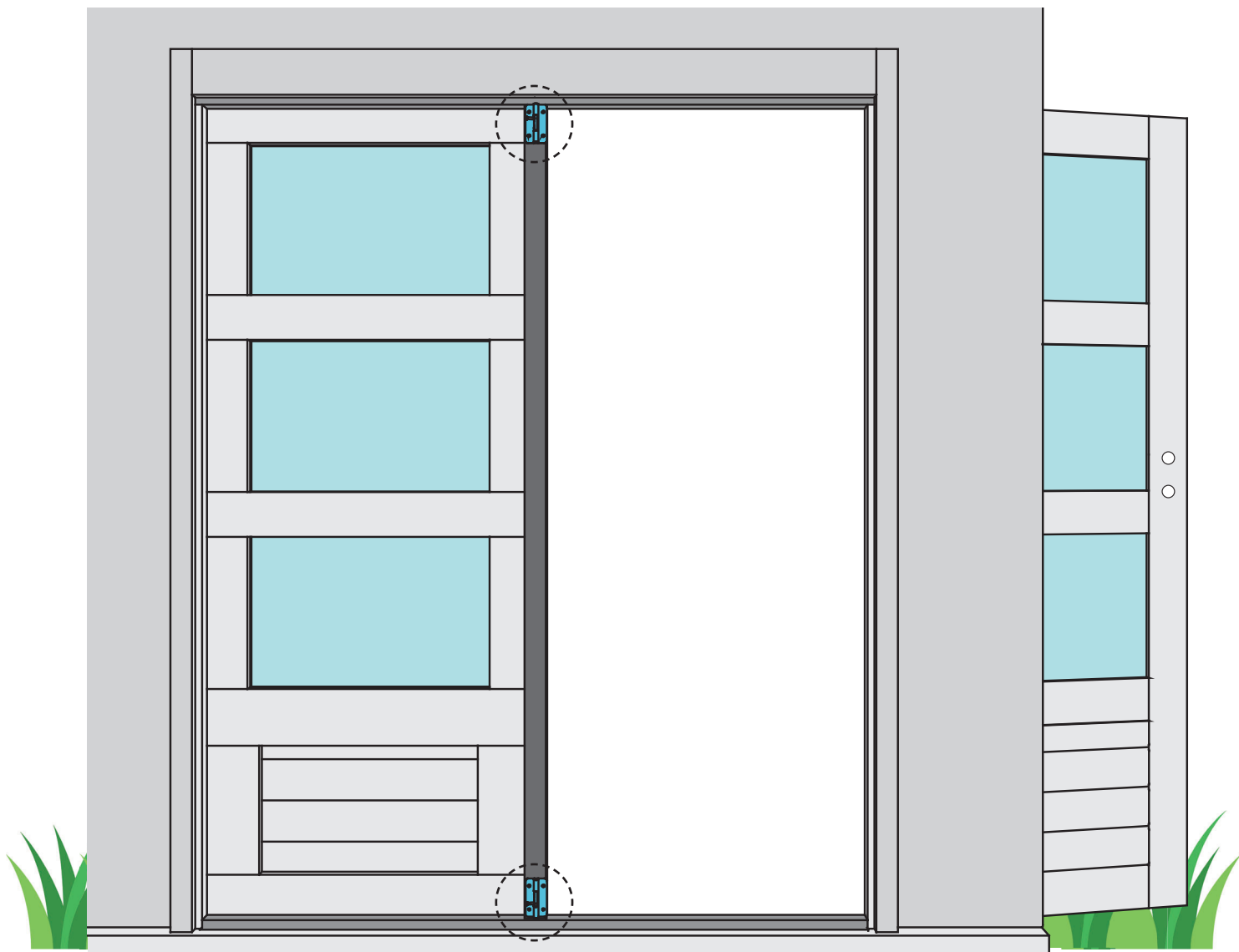
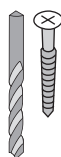

1.

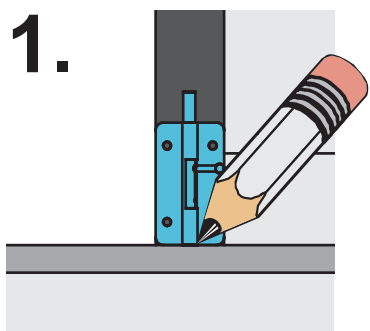

2.

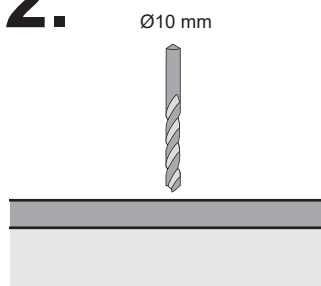

3.

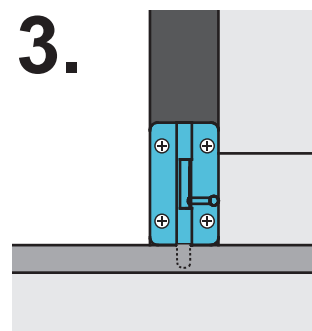



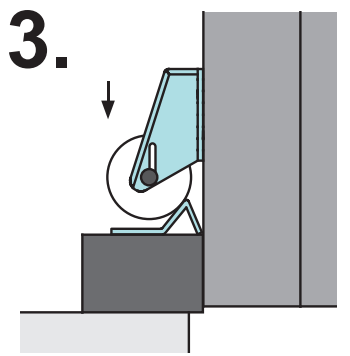
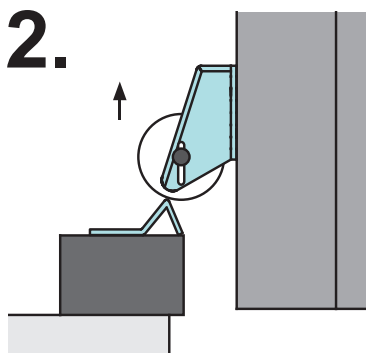
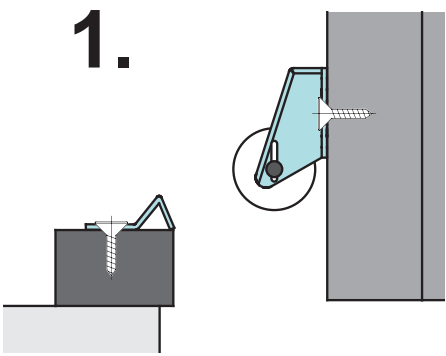
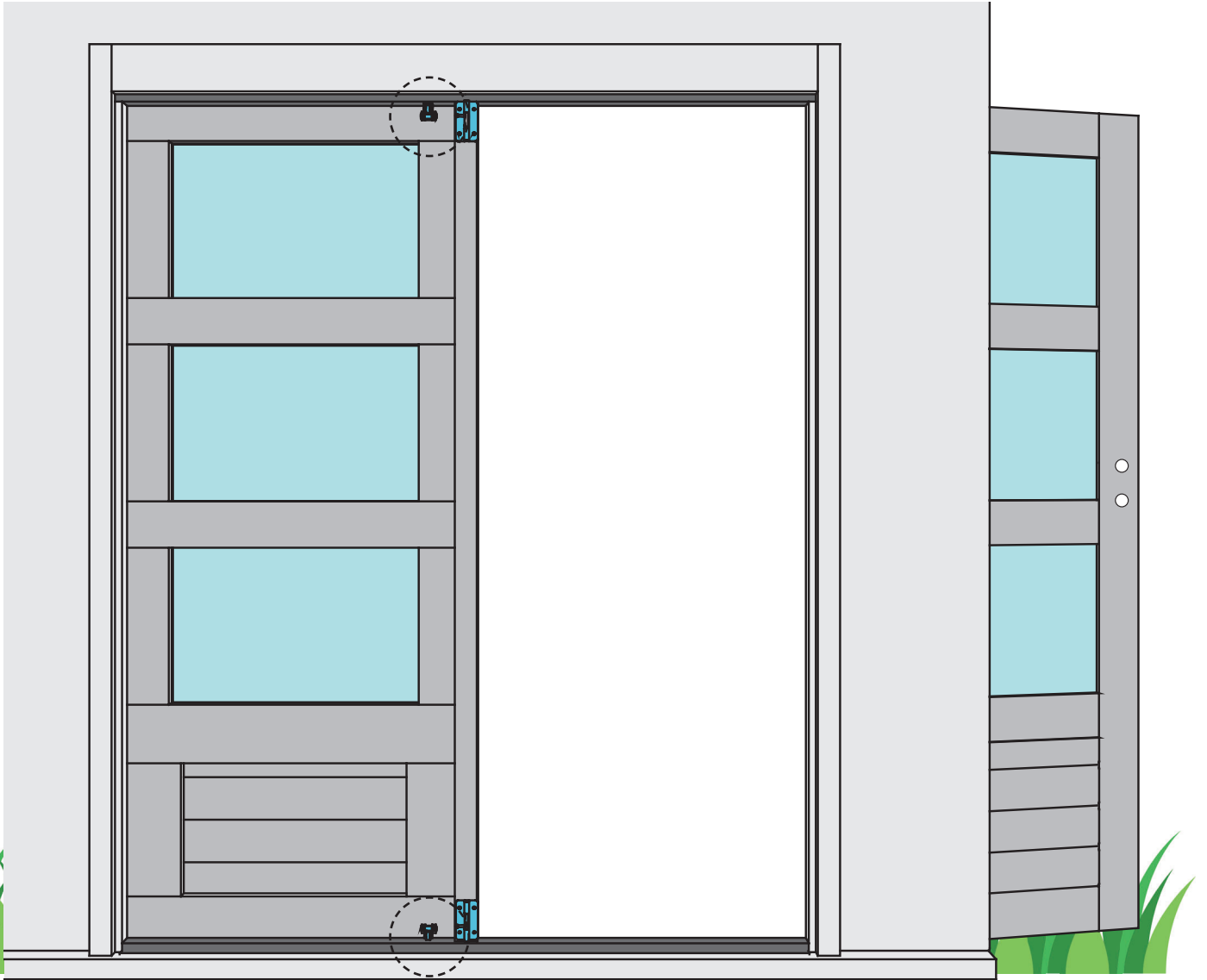
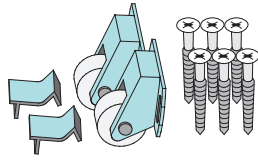

01

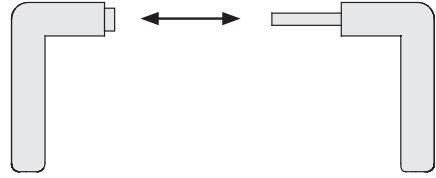
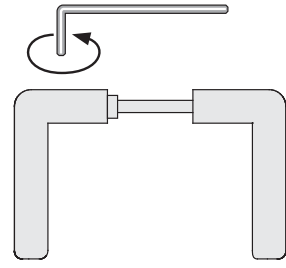
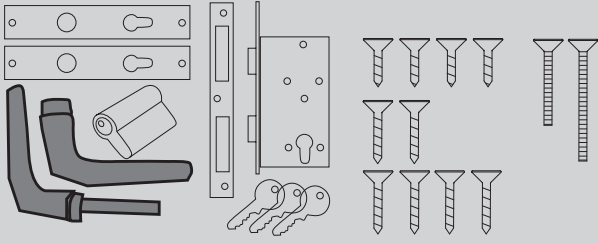
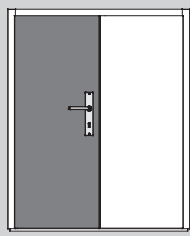

02

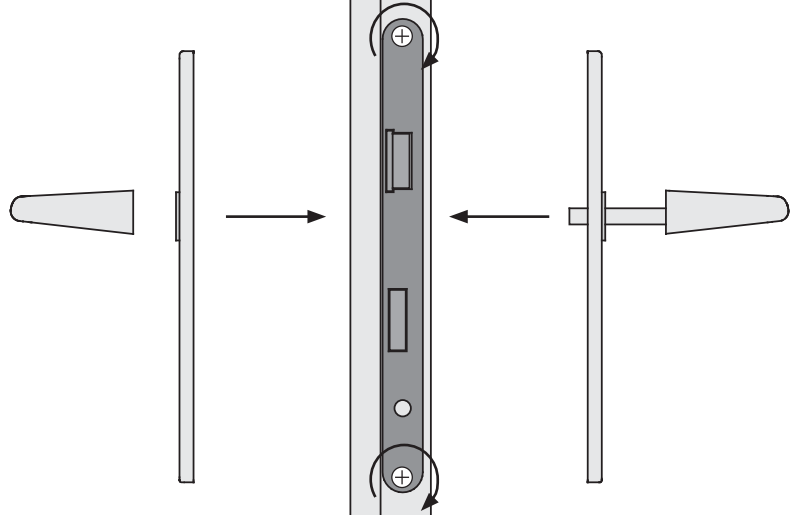
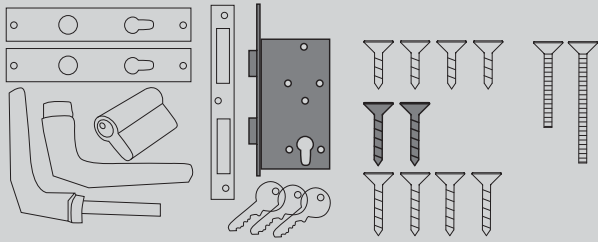
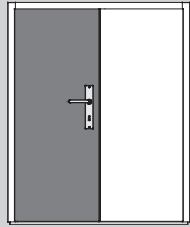

03

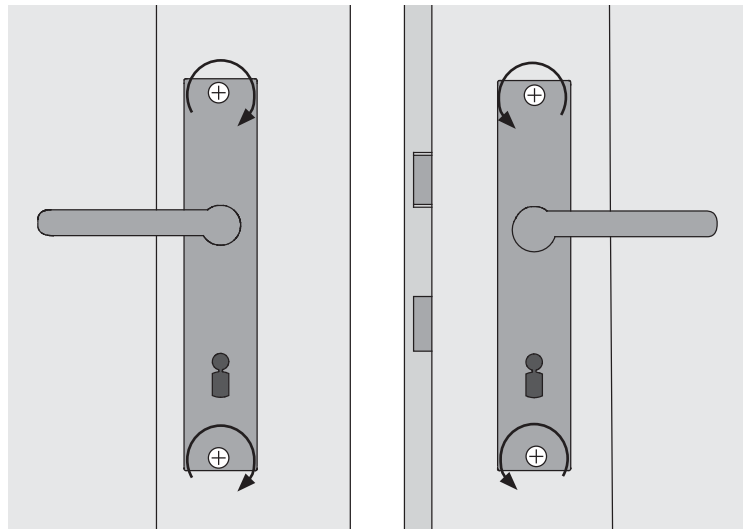
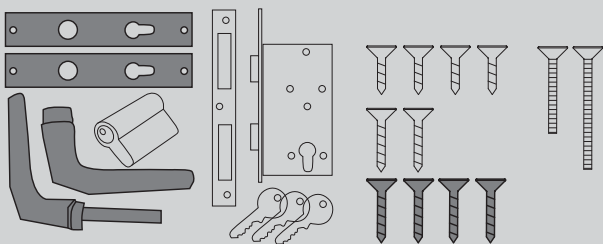
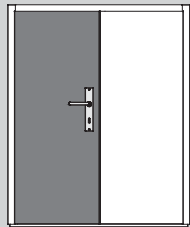

04

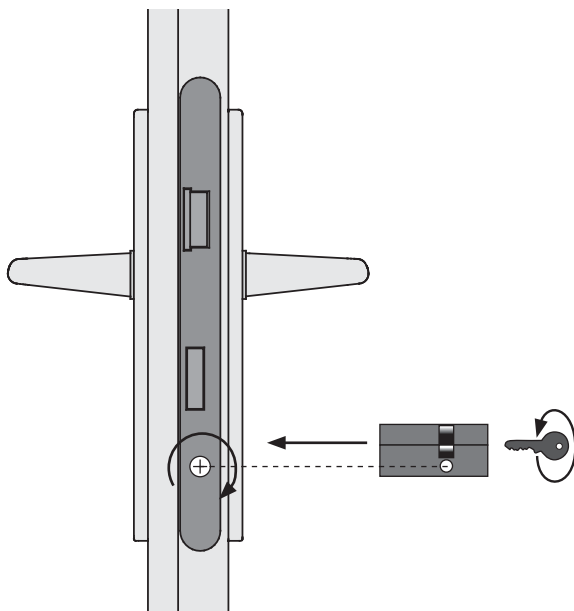
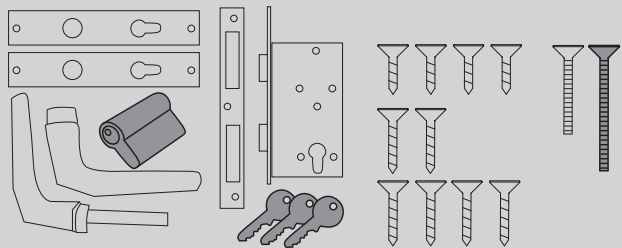
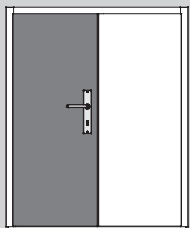

05

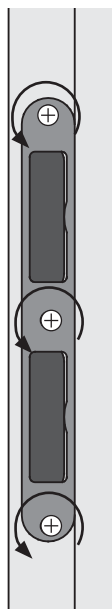
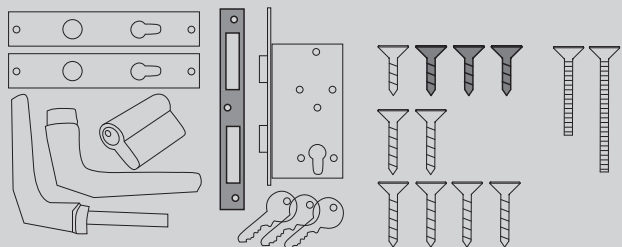
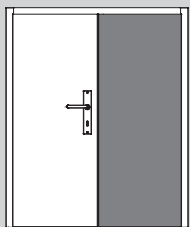

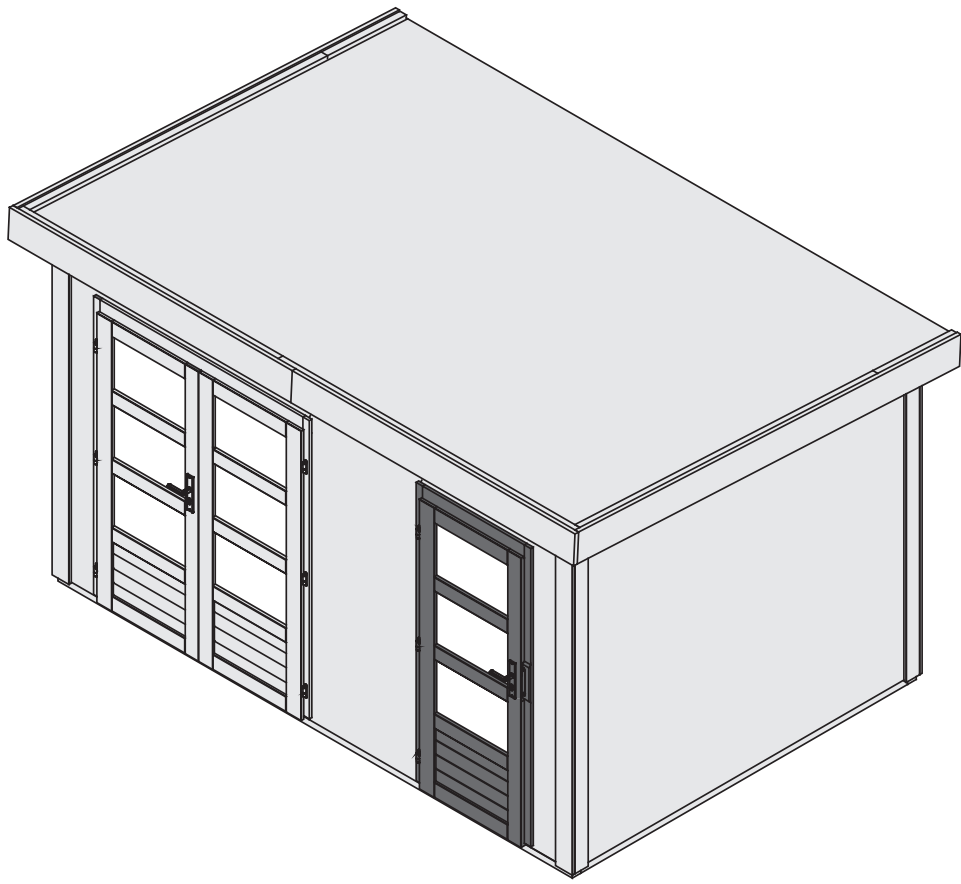

-  Bündig!
-  Flush!
-  Affleurement!
-  Gelijk!
-  I flugt!
-  Aras!
-  Combacia!
-  Stejný!
-  Splakovanje!

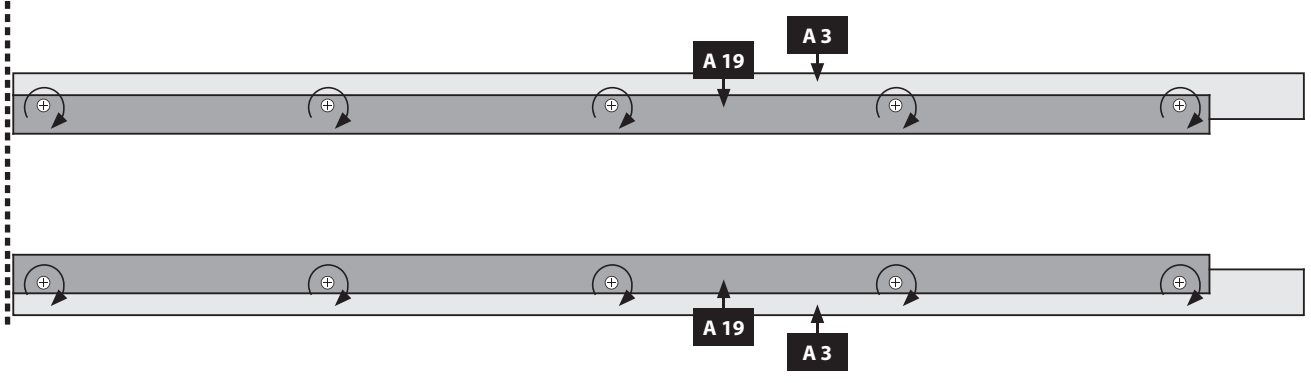
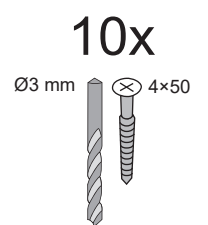
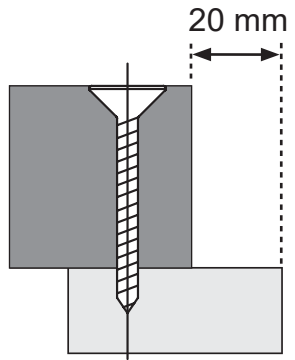



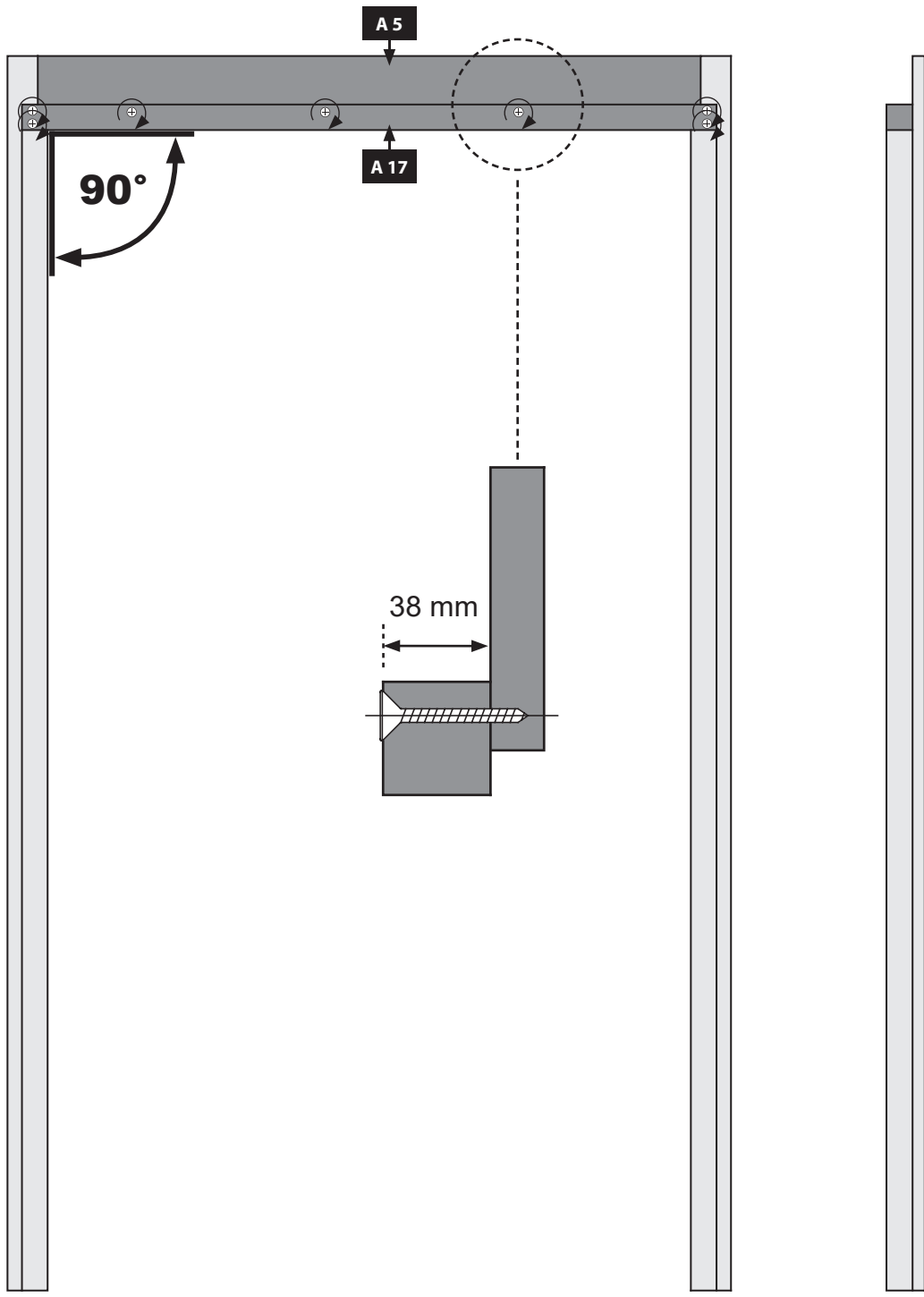
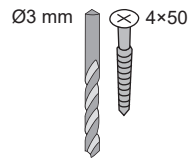

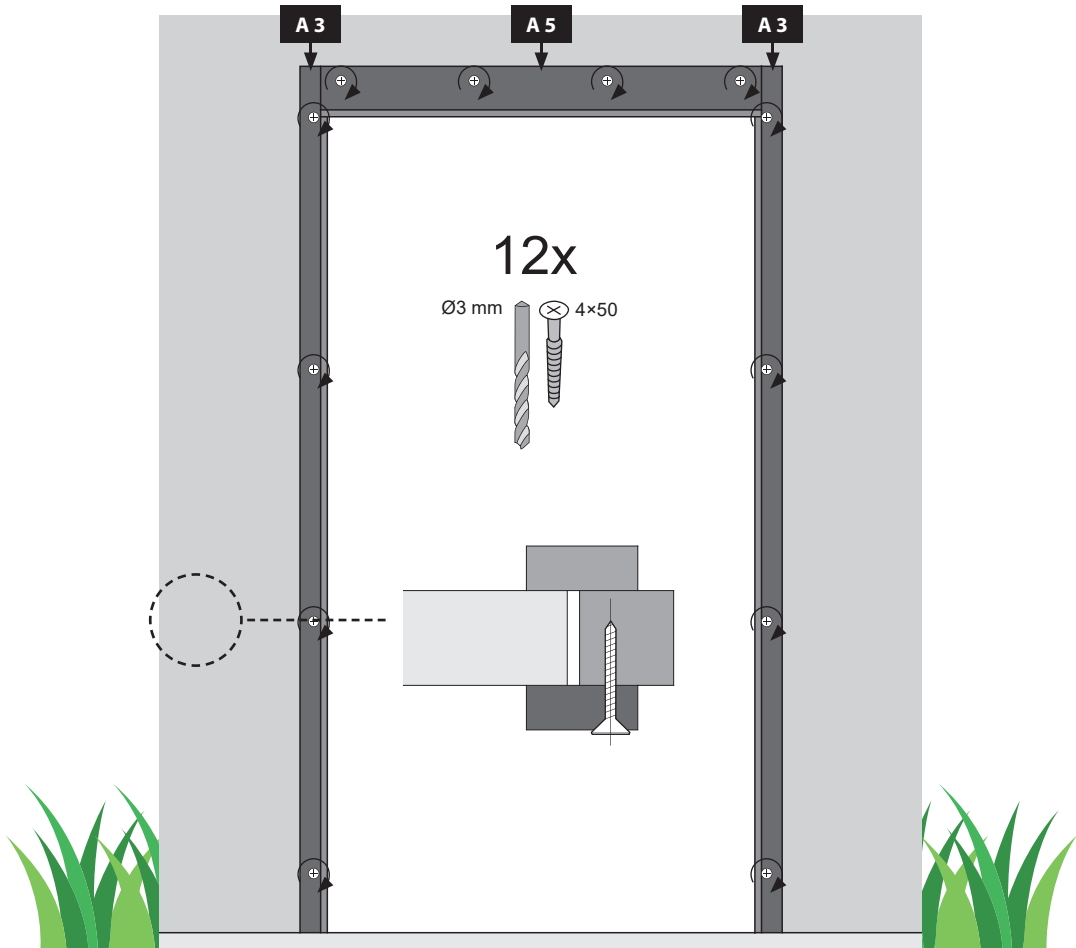
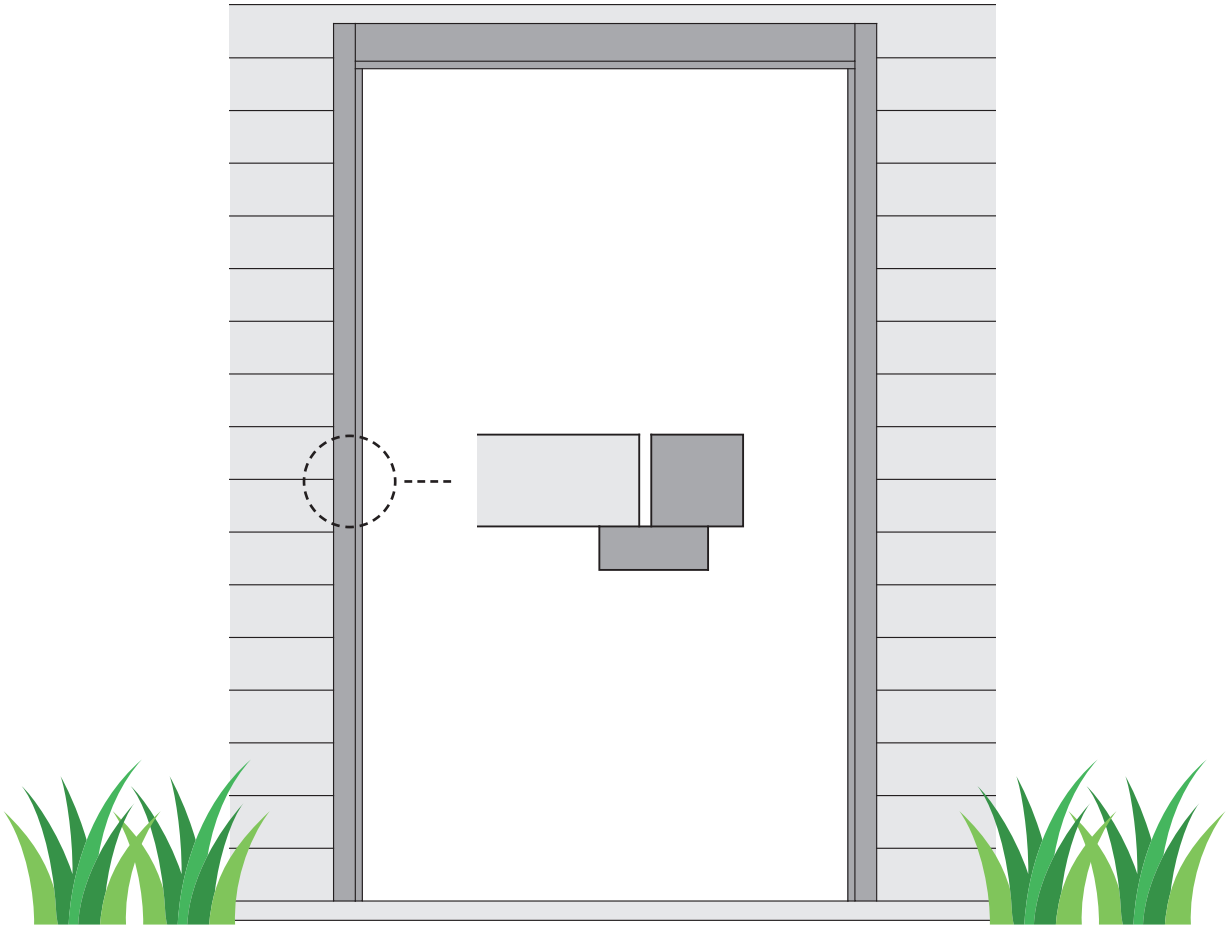

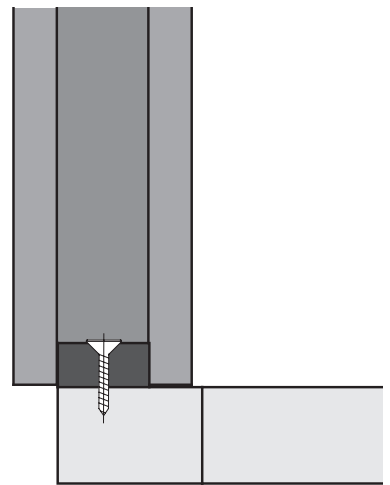
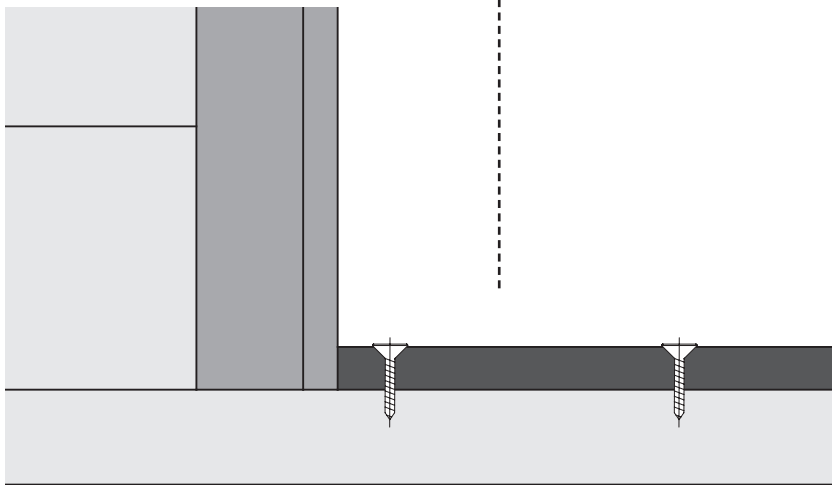
7x









-  Schutzfolie abziehen
-  Remove protective film
-  Retirer le film protecteur

-  Verwijder de beschermende film
-  Fjern beskyttelsesfilm
-  Retire la película protector

-  Rimuovere la pellicola protettiv
-  Odstraňte ochranný film
-  Odstranite zaščitno folijo

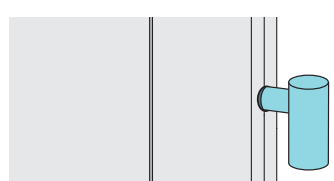
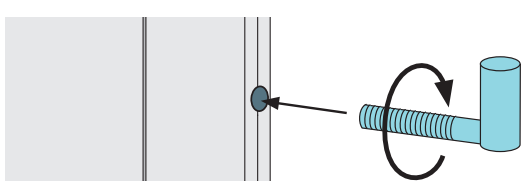
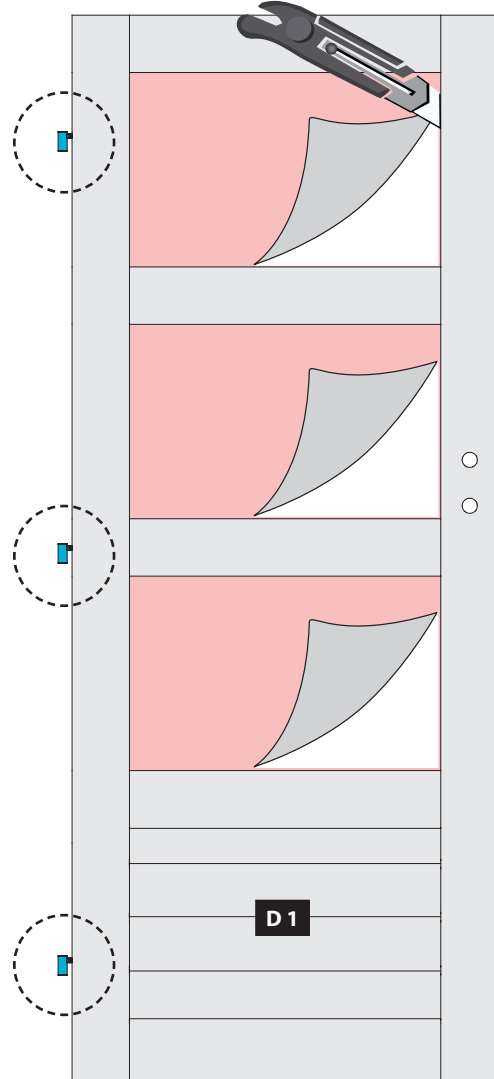



9x

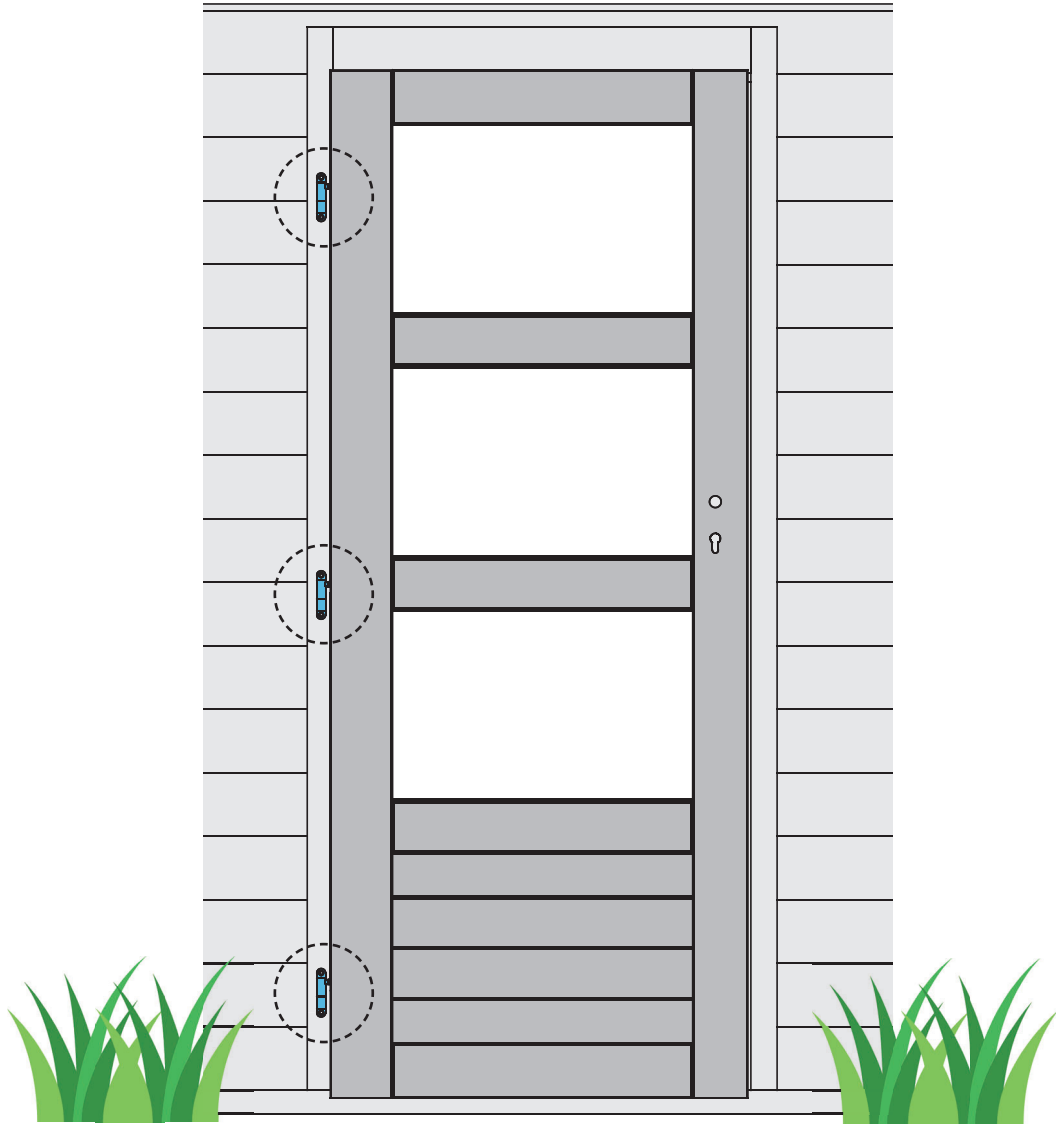
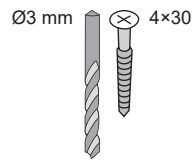

1.

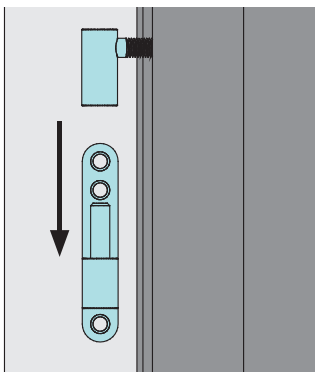

2.

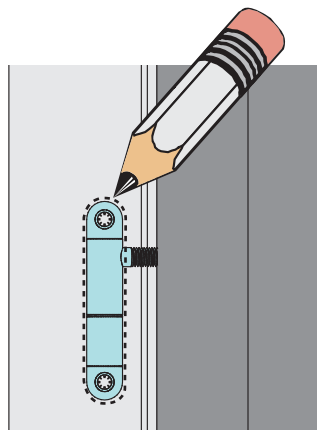

3.

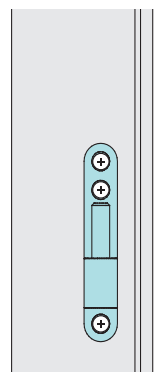

01

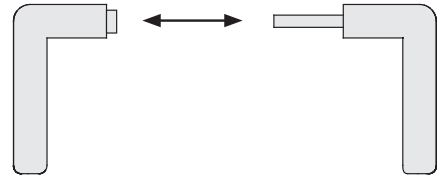
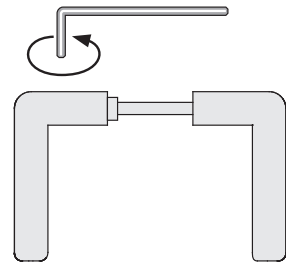
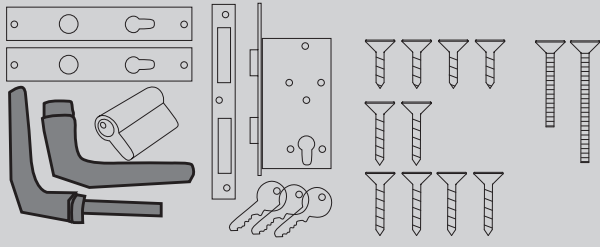
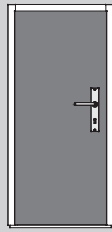

02

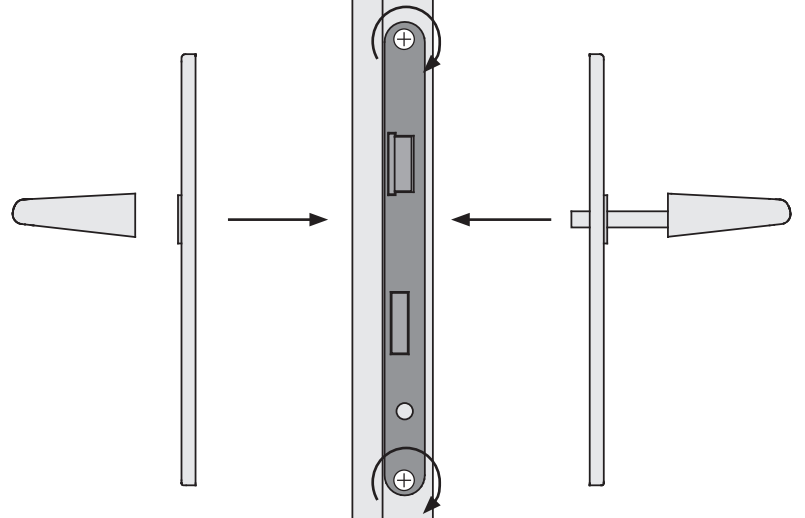
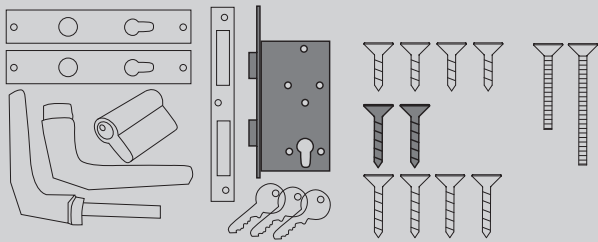
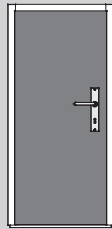

03

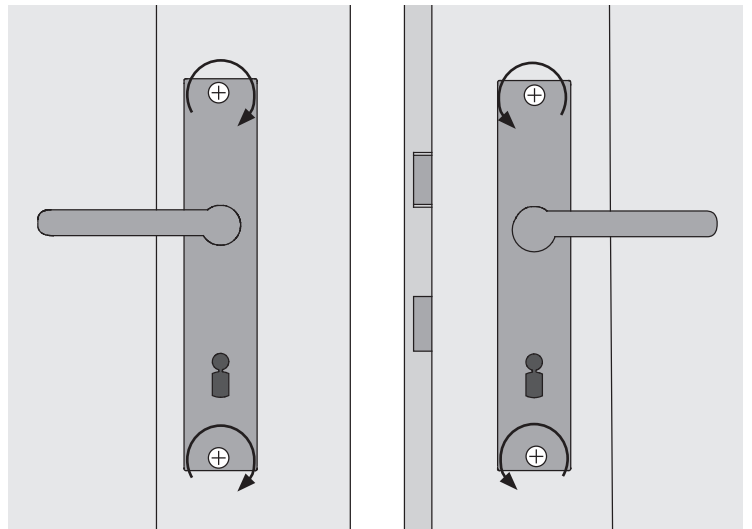
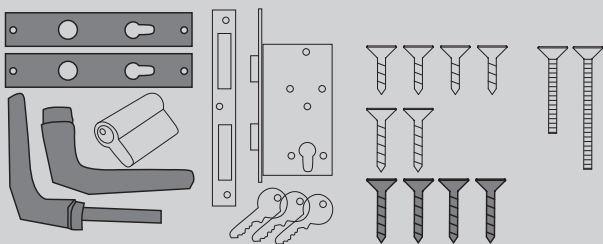
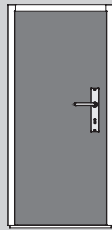

04

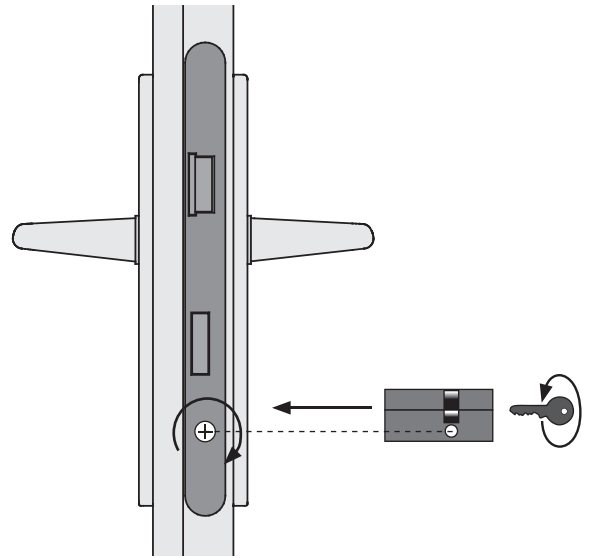
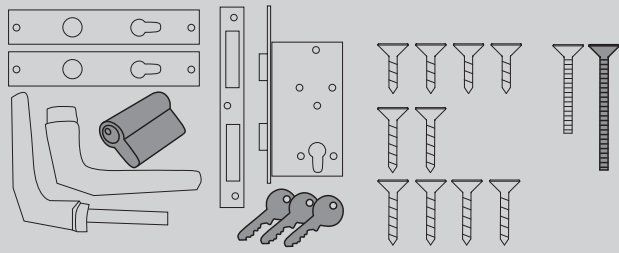

05

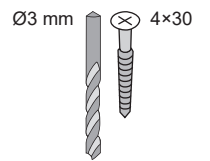
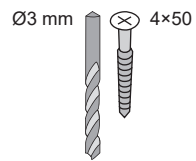
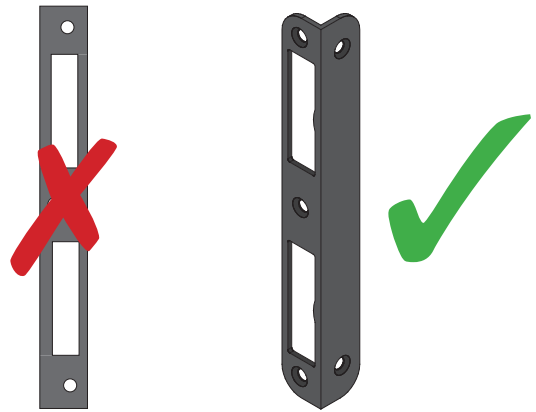
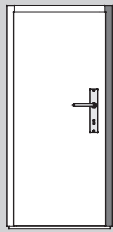
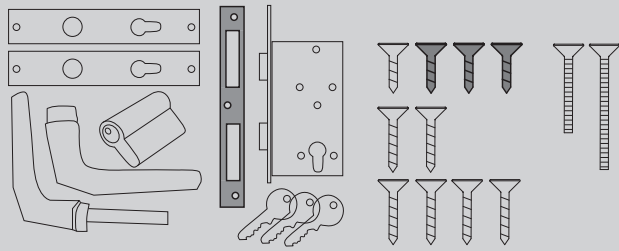

1.

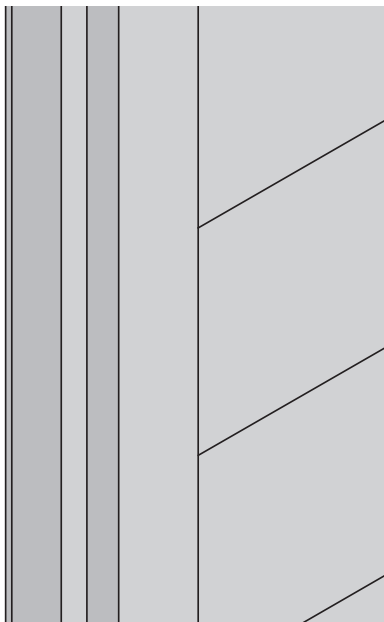

2.

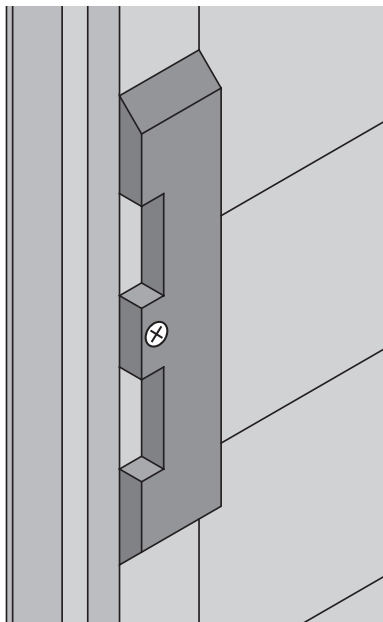

3.

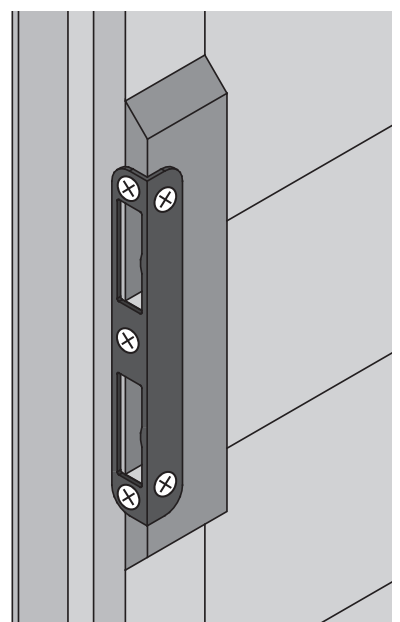

1x

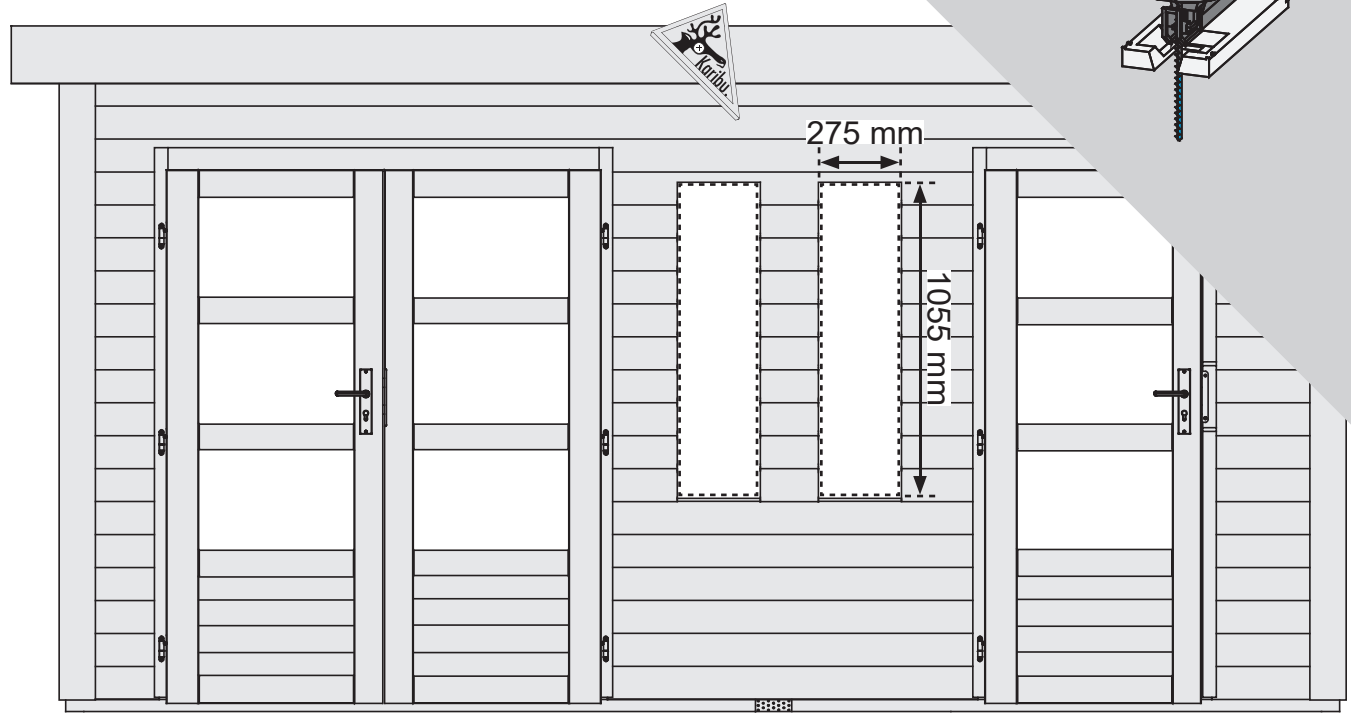
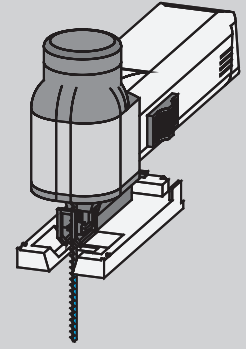
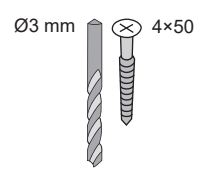

12x

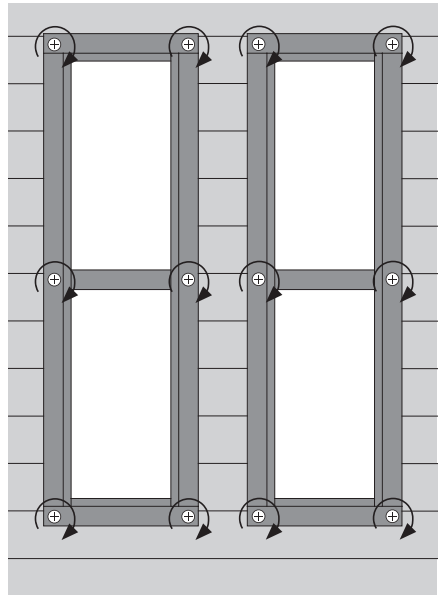
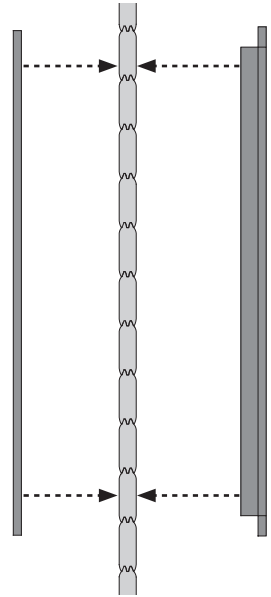
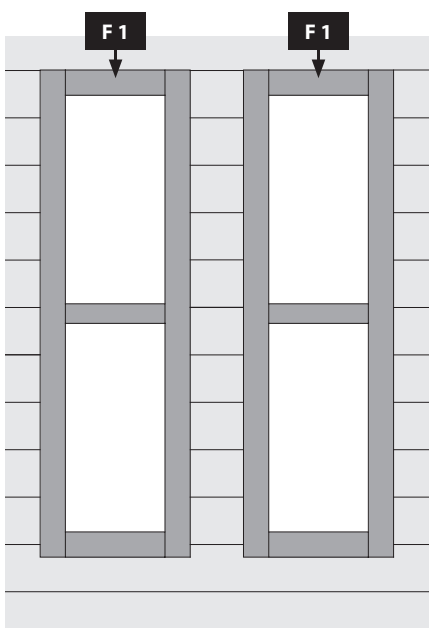
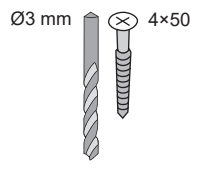

## Handling • Wartung • Pflege der Tür

### Instandhaltung ist Voraussetzung für eine Gewährleistung

Zur nachhaltigen Sicherung der Gebrauchstauglichkeit und Werthaltigkeit, ist auch während des Gewährleistungszeitraumes eine fachgerechte Wartung und Pflege erforderlich, die nicht in die Gewährleistungsverpflichtung eingeschlossen ist. Defekte müssen sofort nach der Entdeckung behoben werden.

### Holzschutztechnische Behandlung der Tür

Alle Bauteile der Tür müssen immer holzschutztechnisch behandelt werden. Die Stellen des Holzes, die später durch den Aufbau nicht mehr zugänglich sind sollten vor dem Aufbau vollständig behandelt werden.

Behandeln Sie das Produkt mit Bläuesperrgrund, anschließend versehen Sie es mit einem zweifachen Schutzanstrich einer offenporigen Holzschutzlasur. Spätestens alle zwei Jahre sollten Sie einen Schutzanstrich wiederholen.

Bei den Türen ist zu beachten, dass die eingesetzten Werkstoffplatten bei ungeeigneten Anstrichstoffen farbliche Abweichungen zu den Türen bekommen.

Bei farbigen und kesseldruckimprägnierten Häusern müssen lediglich die naturbelassenen Holzstellen (Sägeschnitte) und Teile nachbehandelt werden.

Eine gleichmäßige Farbdeckung ist im Innenbereich durch einmaliges Überstreichen zu erreichen. Verwenden Sie dazu einen offenporigen Wasserdispersionslack auf Acrylharzbasis.

Um eine hohe Lebensdauer Ihres Produktes zu gewährleisten sollten beschädigte Stellen sofort repariert werden. Dazu die beschädigte Stelle leicht anschleifen und erneut mit Farbe versehen. Erkundigen Sie sich nach geeigneten Lasuren bei Ihrem Farbenfachberater.

Weiterhin kann man, um eine hohe Lebensdauer der Tür zu gewährleisten und die Schlagregendichtigkeit zu erhöhen, den Holz-Fensterscheibenübergang mit geeigneten Abdichtmassen versiegeln. **Wurden diese Pflegemaßnahmen nicht sachgemäß durchgeführt, kann es zu Formänderungen, Bläue, Pilzbefall der Türen und Zargen und Verlust der Gewährleistung kommen.**

### Reinigung

Regelmäßige Reinigung und Pflege ist eine Grundvoraussetzung zur Erhaltung der Lebensdauer und Funktionsfähigkeit hochwertiger Produkte. Es sind Außen- und Innenseiten und auch der Falzbereich zu reinigen. Die Reinigungsmittel müssen dabei auf das entsprechende Material abgestimmt sein, was vor Beginn der Arbeiten zu prüfen ist.

### Verformung der Tür

Holz reagiert auf Umwelteinflüsse. So kommt es je nach Witterung zum Quellen und Schwinden des Holzes. Dadurch treten Maßabweichungen und leichte Verformungen auf. Um die Schließfähigkeit der Tür zu erhalten, muss je nach Witterung die Tür durch Rein- und Rausdrehen an der Bänder ausgerichtet werden. Ein Verzug der Türen ist zu akzeptieren, solange die Funktion durch die hier aufgeführten Einstellmöglichkeiten gewährleistet ist.

Für Schäden die durch Gewalteinwirkungen entstehen, besteht kein Gewährleistungsanspruch.

### Einstellen der Tür

Die Tür muss genau ausgerichtet werden damit eine einwandfreie Funktion gegeben ist. Der Türrahmen muss rechtwinklig und lotrecht eingebaut sein. Weiterhin muss der Türrahmen so montiert sein, dass er oben und unten dieselbe Breite hat.

Schließt die Tür nicht, oder ein Türblatt hängt schief, kann dies durch leichtes Rein- oder Herausdrehen der Einschraubbänder berichtigt werden. Bis zu 5

Umdrehungen kann man diese Bänder rausdrehen. Wenn Sie eine Doppelflügeltür haben, muss der Feststellflügel stets nach oben und unten mittels der dafür vorgesehenen Beschlägen gesichert werden.

## Handling • Maintenance • Care of the door

### The guarantee is conditional on proper upkeep!

For lasting protection of the value and suitability for use, professional care and maintenance is also recommended during the warranty period; this is not included in the warranty obligations. Defects must be repaired immediately upon detection.

### Wood protection treatment of the door

All parts of the door must receive wood protection treatment. Those sections of the wood, which will not be accessible after installation, should receive complete treatment before installation.

Treat the product with a blue stain blocking coat; afterwards apply a double protective coating of an open-pored wood-protection glaze. Application of a protective coating should be repeated at least every two years.

Please beware that the inserted plates of other material may come to differ in colour to the doors if you use unsuitable coating material. With coloured and boiler pressure impregnated houses, only the exposed natural wood (saw cuts) and parts should need extra treatment.

You can obtain an even colour covering in inside areas with one coat of paint. For that you should use an open-pored, acrylic based water dispersed lacquer. In order to guarantee a long service life of your product you should repair damaged areas immediately. Do this by whetting the damaged area and apply a new coat of paint. Enquire about suitable glazes at your local paint retailer.

Furthermore, you can seal the joining of the wood-window pane with a suitable sealant to guarantee a long service life of the door and prevent leakage from heavy rain. **If these precautions of care are not properly carried out, it can result in deformation, blue stain, fungus infestation in the doors and frames and loss of warranty.**

### Cleaning

Regular cleaning and care is a prerequisite for preserving the service life and functionality of high-value products. Cleaning is to take place outside, inside and also in the rabbet-area. The cleaning agent used must be suitable for the relevant material; please do a test before you start cleaning.

### Deformation of the door

Wood reacts to environmental influences. Weather exposure will lead to swelling and contraction of the wood. This causes variances of dimensions and slight deformation. Dependant on the weather exposure, the door may need realignment by turning the hinges in- or outwards. Some door warpage is acceptable as long as the door can be made to function through the alignment options specified here. The warranty does not cover damage caused by use of excessive force.

### Adjustment of the door

The door must be accurately adjusted to ensure trouble-free operation. The door frames must be installed right-angled and perpendicular. Furthermore, they must be installed so the width of the frame is the same at the top and bottom. If the door doesn't close or if one panel is askew, this can be rectified by limited in- or outwards turning of the hinges. You can turn the hinges outwards up to 5 rotations. If you have a double-door, the door to be secured must always be correctly aligned at the top and bottom with the appropriate hinges.

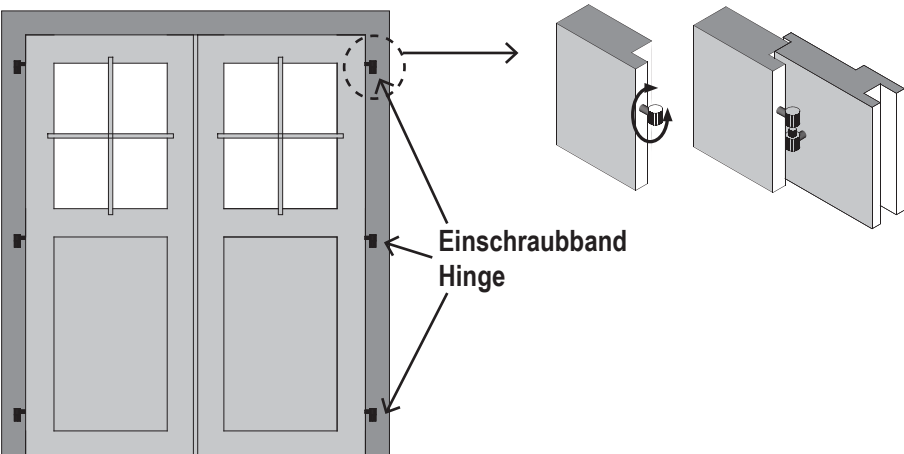

Beispiele für die Einstellung der Türen:  
Examples of the adjustment of the doors:

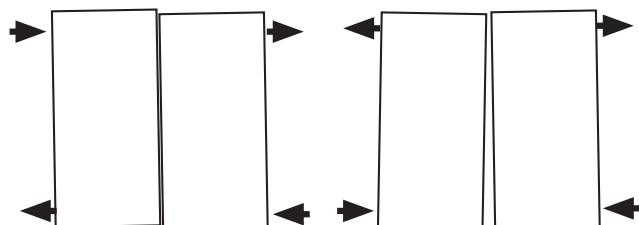

## Usage • Maintenance • Entretien de la porte

### La garantie liée au matériel est subordonnée à son entretien.

Afin d'assurer au matériel un fonctionnement et une valeur durables, une maintenance et un entretien appropriés pendant toute la durée de la garantie sont nécessaires mais ne font pas partie intégrale de la garantie. Il convient de remédier aux anomalies ou aux défauts aussitôt après leur constatation.

### Technique de traitement pour la préservation du bois

Les éléments de la porte au complet font l'objet d'une technique de traitement de préservation du bois. Après le montage, certaines parties du bois ne seront plus accessibles. Elles seront par conséquent traitées entièrement avant le montage. Apposer avec une couche d'anti-corrosif sur le bois puis passer deux couches de lasure à pores ouverts pour bois. Repasser une couche de lasure de protection au moins tous les deux ans. Noter qu'une peinture non appropriée pour les panneaux en contreplaqué peut donner ultérieurement une couleur différente de celle des portes. En ce qui concerne les maisonnettes prépeintes et autoclavées, seuls les emplacements où le bois brut apparaît, tels que les parties sciées et les divers éléments, doivent subir un traitement complet. Il suffit de passer une seule couche sur la surface intérieure pour obtenir une couleur homogène. Pour ce faire, il est conseillé d'utiliser une laque à dispersion aqueuse et à pores ouverts à base de résine acrylique. Afin d'assurer au produit une longévité maximum, il est recommandé de réparer immédiatement les parties endommagées qui seront légèrement poncées dans un premier temps puis enduites d'une nouvelle couche de peinture. Renseignez-vous sur les lasures appropriées auprès de votre magasin de peintures. Pour obtenir une longévité maximum de la porte et une optimisation de son imperméabilité contre les intempéries, colmater les espaces entre l'encadrement et la vitre de la fenêtre avec un mastic ou une pâte de colmatage adaptés. Ces mesures d'entretien, si elles ne sont pas appliquées de manière appropriée, peuvent provoquer des déformations, des attaques de corrosion, des attaques fongiques des portes et des encadrements et entraînent la perte de la garantie liée au produit.

### Nettoyage

Un nettoyage et un entretien réguliers garantissent une longévité maximum et un excellent fonctionnement des produits de haute qualité. Nettoyer les parois extérieures et intérieures ainsi que les jointures. Les produits de nettoyage doivent être appropriés au matériel à traiter. Vérifier leur compatibilité avant le commencement des travaux.

### Déformation de la porte

Le bois réagit sous l'influence de son environnement. C'est ainsi qu'il gonfle et qu'il se resserre selon le temps qu'il fait. Il peut en résulter des variations de proportions et des déformations. C'est pourquoi, afin d'obtenir la fermeture exacte d'une porte, il est nécessaire de procéder à un ajustement de la fixation au cours des changements de saison en enfonçant les fiches vers l'intérieur ou en les dévissant vers l'extérieur. Une déformation des portes est acceptable dans la mesure où son fonctionnement est assuré par les diverses possibilités de réglage décrites ici. Aucun droit de garantie ne sera reconnu en cas de dégâts provenant de manipulations violentes.

### Réglage de la porte

Pour obtenir un fonctionnement parfait, la porte doit être assemblée avec précision. L'encadrement doit être assemblé à angle droit et à la verticale. Il doit également présenter la même largeur dans sa partie supérieure et dans sa partie inférieure. Si une porte ne ferme pas ou si un battant est de travers, enfoncer les fiches à visser ou les dévisser légèrement vers l'extérieur (5 rotations sont possibles). Dans le cas

d'une porte à deux battants, le battant de verrouillage doit toujours être fixé en haut et en bas avec les ferrures prévues à cet effet.

## Handling • Onderhoud • Schoonmaken van de deur

### Onderhoud is een voorwaarde voor garantie!

Om de bruikbaarheid en waardevastheid duurzaam te waarborgen, is ook tijdens de garantieperiode deskundig onderhoud noodzakelijk; dit maakt geen deel uit van de garantieverplichting. Defecten moeten onmiddellijk na ontdekking ervan worden verholpen.

### Houtbeschermingstechnische behandeling van de deur

Alle onderdelen van de deur moeten altijd houtbeschermingstechnisch worden behandeld. De plaatsen van het hout die later als het huisje is gemonteerd niet meer toegankelijk zijn, dient u vóór het opbouwen volledig te behandelen. Behandel de deur vóór het opbouwen met antiblaauwmiddel, daarna voorzien van een dubbele beschermende coating van ademende houtbeschermende beits. Uiterlijk om de twee jaar dient u de deklaag over te schilderen. Bij de deurtjes moet in acht worden genomen dat de gebruikte platen materiaal in geval van ongeschikte soorten verf kleurafwijkingen t.o.v. de rest van de deurtjes krijgen. Bij geverfde en onder vacuümdruk geïmpregneerde huisjes hoeven alleen de naturel houten onderdelen (zaagkant) en houtdelen te worden nabehandeld. Een gelijkmatig dekkende kleur kan binnen door één keer overschilderen worden verkregen. Gebruik daarvoor een ademende watergedragen dispersielak op acrylharsbasis. Om een lange levensduur van uw product te garanderen, dienen beschadigde plaatsen onmiddellijk te worden gerepareerd. Daarvoor de beschadigde plaats licht opschuren en van een nieuwe verflaag voorzien. Informeer naar geschikte beitsen bij uw verfspecialzaak. Verder kunt u, om een lange levensduur van de deur te waarborgen en de slagregendichtheid te verbeteren, de overgang tussen het hout en de ruiten met een geschikte kit afdichten. **Als deze onderhoudsmaatregelen niet oordeelkundig worden uitgevoerd, bestaat het risico van vormveranderingen, blauwheid, schimmelaantasting van de deuren en kozijnen en daarmee verlies van de garantie.**

### Schoonmaken

Regelmatig schoonmaken en onderhoud is een basisvoorwaarde voor het behoud van de levensduur en de goede werking van hoogwaardige producten. Binnen en buitenkanten alsmede de sponning moeten goed worden schoongehouden. Daarbij moeten de schoonmaakmiddelen zijn afgestemd op het betreffende materiaal, hetgeen vóór het begin van de werkzaamheden dient te worden gecontroleerd.

### Vervorming van de deur

hout reageert op omgevingsinvloeden. Zo zal het hout afhankelijk van de weeromstandigheden opzwellen en krimpen. Daardoor treden er maatafwijkingen en lichte vervormingen op. Om ervoor te zorgen dat de deur goed blijft sluiten, moet afhankelijk van de weersgesteldheid de deur door in- en uitschroeven van de scharnieren worden afgesteld. Iets scheefftrekken van de deuren moet worden geaccepteerd zolang de werking door de hier genoemde instelmogelijkheden is gewaarborgd. Voor schade die ontstaat door het toepassen van geweld bestaat geen aanspraak op garantie.

### Instellen van de deur

De deur moet nauwkeurig worden afgesteld om goed te kunnen werken. Het deurkozijn moet haaks en loodrecht zijn gemonteerd. Verder moet het frame zo zijn gemonteerd dat het boven en onder even breed is. Als de deur niet sluit of een deurblad hangt scheef, dan kan dit worden gecorrigeerd door de schroefscharnieren iets naar binnen of naar buiten te draaien. Deze scharnieren kunnen max. 5 slagen naar buiten worden gedraaid. Als u een dubbele openslaande deur heeft, moet het vaste gedeelte steeds naar boven toe en met behulp van het daarvoor bedoelde sluitwerk worden vastgezet.

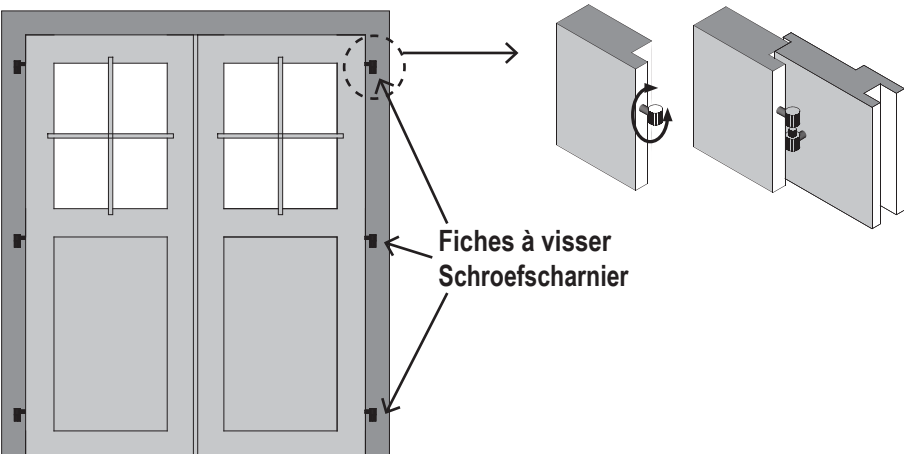

Exemples de réglage des portes:  
Voorbeelden voor het instellen van de deuren:

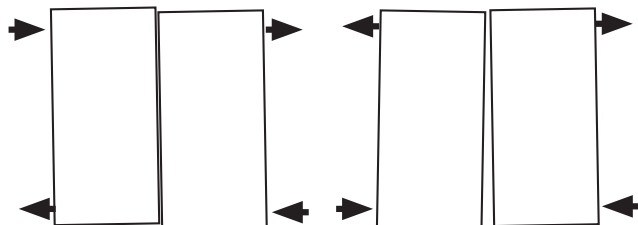



**Una corretta manutenzione è la premessa per il ricorso alla garanzia.**

Per garantire l'idoneità all'uso del portoncino e mantenerne inalterato il valore nel tempo, anche durante il periodo della garanzia sono necessarie una manutenzione e una cura adeguate che non sono comprese nell'obbligo della garanzia. Eventuali difetti devono essere corretti subito dopo il rilevamento.

**Trattamento protettivo del portoncino**

Tutte le parti in legno del portoncino devono essere sempre sottoposte a trattamento protettivo. Prima dell'installazione, è necessario eseguire il trattamento integrale dei punti che successivamente non risulteranno più accessibili. Nel caso venga utilizzato un prodotto contro il turchino, prevedere successivamente l'applicazione di un doppio strato di impregnante per legno a poro aperto. Si consiglia di ripetere l'applicazione dello strato protettivo al massimo ogni due anni. È necessario ricordare che, in caso di utilizzo di vernici non adatte, le placche in plastica inserite potranno presentare delle differenze cromatiche rispetto ai portoncini. Nel caso di edifici colorati e impregnati a pressione, il trattamento successivo interesserà solamente i punti e le parti in legno lasciati al naturale. Una copertura del colore uniforme nell'area interna deve essere raggiunta verniciando una volta la parte interna con una vernice a base di resine acriliche in dispersione acquosa a poro aperto. Per assicurare una lunga durata del prodotto, eventuali punti danneggiati devono essere riparati in modo tempestivo, carteggiando leggermente e applicando nuovamente il colore. Il vostro rivenditore di fiducia saprà consigliarvi degli impregnanti adatti. Per garantire una lunga durata del portoncino e aumentarne la tenuta all'acqua, è inoltre possibile sigillare la giunzione vetrolegno con un'apposita pasta.

**Un'esecuzione non corretta delle operazioni indicate può determinare la comparsa di deformazioni, azzurrimento e funghi sul legno di porte e telai e il conseguente decadimento della garanzia.**

**Pulizia**

Una pulizia e una cura regolari sono essenziali ai fini della durata e dell'efficienza di prodotti pregiati. La pulizia deve essere effettuata sul lato interno, su quello esterno e anche nella scanalatura nel telaio. Prima di iniziare la pulizia, verificare la compatibilità dei detergenti con il materiale da pulire.

**Deformazione del portoncino**

Il legno reagisce alle condizioni ambientali. Il rigonfiamento e il ritiro, cui può essere soggetto il legno a seconda delle condizioni atmosferiche, comportano variazioni dimensionali e lievi deformazioni. Affinchè il portoncino continui a chiudersi correttamente, può rendersi necessario un intervento sulle cerniere, avvitandole o svitandole, a seconda delle condizioni atmosferiche. Finché il funzionamento viene garantito dalle possibilità di regolazione indicate, la deformazione del portoncino è considerata accettabile. La garanzia non copre danni derivanti dall'uso di forza.

**Regolazione del portoncino**

Per assicurare il corretto funzionamento del portoncino, lo stesso deve essere posizionato con precisione. Il telaio deve essere incassato in posizione perpendicolare al pavimento e ad angolo retto. Il telaio va inoltre montato in modo da avere la stessa larghezza sia superiormente che inferiormente. Se il portoncino non si chiude o un battente non è ben bilanciato, il problema può essere corretto intervenendo sulle cerniere a vite, avvitandole e svitandole fino a 5 giri. Nel caso di portoncini a doppio battente, il battente fisso deve essere sempre assicurato verso l'alto e verso il basso per mezzo degli appositi meccanismi.

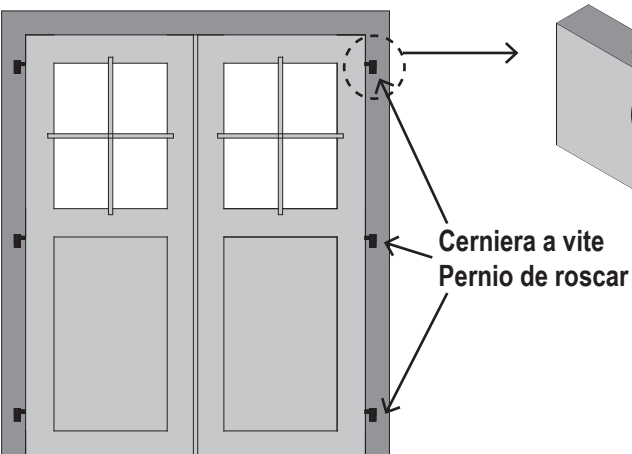

**¡Para cualquier garantía es condición previa que se realice la conservación!**

Para asegurar de forma duradera la utilidad y el valor también es necesario que se realice durante el periodo de validez de la garantía el mantenimiento y cuidado apropiados, que no están incluidos en las obligaciones de la garantía. Los defectos deberán ser reparados inmediatamente después de detectarse.

**Tratamiento técnico protector de madera de la puerta**

Todas las piezas constructivas de la puerta deberán tratarse siempre según la técnica para protección de madera. Aquellas partes o zonas de la madera que, tras el montaje, ya no serán accesibles deberán ser tratadas completamente antes de proceder a su montaje. Trate usted el producto con una imprimación protectora contra el hongo de azuleo, a continuación aplíquelo dos manos de barniz protector de madera de poros abiertos. Como muy tarde cada dos años se debería aplicar de nuevo una mano de protección. En las puertas deberá tenerse en cuenta que las planchas utilizadas pueden presentar variaciones de color, si no se utilizan los materiales de pintura apropiados. En casas de colores e impregnadas por medio de caldera a presión solamente se deberán tratar posteriormente las zonas (cortes serrados) y piezas o partes de madera que se hayan dejado al natural. En el interior se deberá conseguir una cubrición de pintura homogénea mediante la aplicación de una sola mano. A fin de garantizar una larga duración de vida útil de su producto las zonas o partes dañadas se deberán reparar de inmediato. Para ello se lijará un poco las zonas dañadas y se volverá a aplicar pintura. Infórmese sobre los barnices apropiados en su asesor técnico de colores. Para garantizar una larga duración de vida útil de la puerta y para aumentar la impermeabilidad a la lluvia que viene de lado por el viento se deberán sellar las transiciones entre la madera y el vidrio de la ventana con alguna masilla selladora adecuada. **Si no se han llevado a cabo correctamente estas medidas de conservación y cuidado, podrán producirse deformaciones, hongos de azuleo y hongos en general en las puertas, bordes y cercos, con lo que se puede extinguir la garantía.**

**Limpieza**

La limpieza y el cuidado periódicos son condición previa básica para mantener la vida útil y la funcionalidad de los productos de alta calidad. También se deberán limpiar las partes interiores y exteriores en la zona de los encajes y las ensambladuras. Los detergentes o agentes limpiadores deberán ser apropiados para cada material en cuestión. Se deberá comprobar la idoneidad de dichos agentes antes de comenzar el trabajo.

**Deformación de la puerta**

La madera reacciona a las influencias del medio ambiente. Así, según el clima que haga, pueden producirse hinchamientos y encogimientos de la madera. Debido a este fenómeno se producen variaciones o desviaciones de las medidas y dimensiones y, por tanto, ligeras deformaciones. Para mantener la capacidad de cierre de la puerta se adaptará la misma, según las condiciones climáticas y sus repercusiones, girando hacia fuera o hacia adentro los pernios. Se podrá aceptar una deformación de la puerta, siempre que su funcionamiento siga garantizado mediante las posibilidades de ajuste indicadas en las presentes instrucciones. No se asumirá garantía alguna por aquellos daños que hayan sido causados por acción violenta.

**Ajustar la puerta**

La puerta deberá estar exactamente alineada a fin de que su funcionamiento perfecto esté garantizado. El marco de la puerta deberá estar montado en ángulo recto y perpendicularmente. Asimismo el marco de la puerta deberá estar montado de manera que tenga el mismo ancho arriba que abajo. Si la puerta no cierra o una hoja de la misma está torcida, se podrá corregir roscando o desenroscando un poco los pernios. Estos pernios se pueden desenroscar hasta 5 vueltas. Si tiene usted una puerta de dos hojas, la hoja de retención siempre se deberá fijar tanto arriba como abajo con los herrajes correspondientes previstos para dicho fin.

**Esempio di regolazione del portoncino:  
Ejemplos para ajustar las puerta:**



## Ošetřování a údržba dveří

### Údržba je předpokladem pro zachování záruky!

Pro udržení trvalé funkčnosti a dobrého stavu je třeba i během záruční lhůty provádět odbornou péči a údržbu, která není zahrnuta v záručních podmínkách. Veškerá poškození musí být ihned po jejich zjištění odstraněna.

### Ochranný nátěr dřevěných dveří:

Všechny části dveří musí být ošetřeny ochranným nátěrem. Místa, která budou po montáži nedostupná, je třeba ošetřit ještě před montáží. Nejprve ošetřete výrobek nátěrem pro ochranu dřeva proti zamodralosti, následně jej opatřete dvojí vrstvou ochranné lazury s otevřenými póry. Nejpozději každé dva roky byste měli ochranný nátěr nanést znovu. U dveří je třeba dát pozor na to, aby při použití nevhodných nátěrových látek nedošlo k barevným odlišnostem mezi použitými deskami a dveřmi. U barvených a tlakovou impregnací ošetřených domků je třeba ošetřit pouze ty části a díly, které nebyly dosud ošetřeny (např. Vámi provedené řezy). Souvislý barevný nátěr ve vnitřní části získáte jedním natřením. Použijte k tomu disperzní vodou ředitelný lak s otevřenými póry na bázi akrylové pryskyřice. Aby byla zachována dlouhá životnost produktu, měla by být poškozená místa ihned opravena. Poškozené místo byste měli nejprve lehce obrousit a poté znovu opatřit barevným nátěrem. Na použití vhodných lazur se informujte u odborníků. Pro udržení dlouhé životnosti dveří a zvýšení jejich odolnosti proti prudkému dešti je možno utěsnit přechod mezi tabulí skla a dřevem příslušnou těsnící hmotou.

**Pokud nebudou tato opatření řádně provedena, může dojít u dveří a zárubní k deformacím, zamodráním, nebo napadením houbou a tím i ztrátě záruky.**

### Čištění

Pravidelné čištění a péče jsou základním předpokladem pro udržení dlouhé životnosti a funkčnosti produktu. Je třeba čistit vnitřní i vnější stranu, a stejně tak oblast záhybů. Je třeba používat čisticí prostředky k tomu určené, což je třeba před započatím práce znovu překontrolovat.

### Deformace dveří

Dřevo reaguje na vlivy okolního prostředí. Tím dochází k bobtnání a vysychání dřeva. Vznikají tak lehké rozměrové odchylky a deformace. Aby byla zachována těsnost dveří, je třeba dveře vyrovnat zašroubováním nebo vyšroubováním závěsů dveří. **Pokřivení dřeva je akceptovatelné do té míry, pokud je možno pomocí výše uvedených úprav zaručit jeho funkčnost.**

Na škody, které jsou způsobeny použitím síly se záruka nevztahuje.

### Nastavení dveří

Dveře musí být přesně vyrovnány, aby byla zaručena jejich bezchybná funkčnost. Rám dveří musí být pravoúhlý a kolmý. Zároveň musí být rám umístěn tak, aby měl nahoře i dole stejnou šířku. Pokud nelze dveře zavřít, nebo jsou dveře nakřivo, je možné toto upravit zašroubováním nebo vyšroubováním závěsů dveří. Závěsy lze vyšroubovat až o 5 otočení. Pokud máte dvoukřídlové dveře, musí být pevně stojící křídlo vždy nahoře a dole zajištěno aretací.

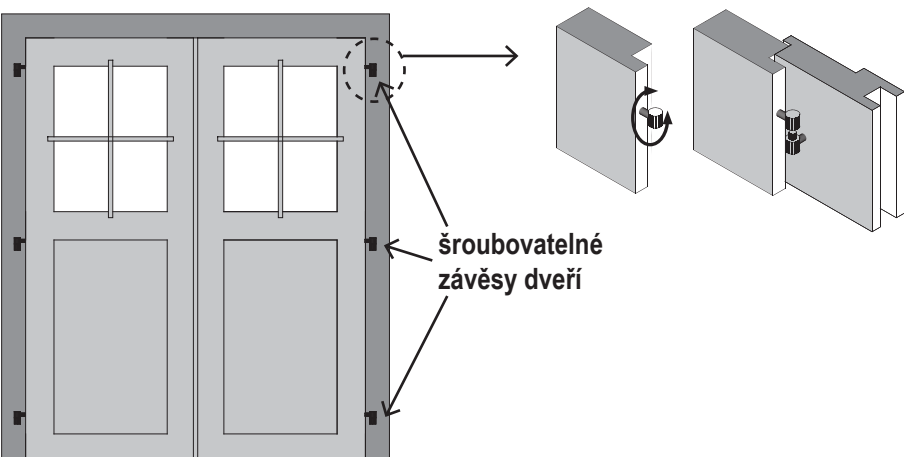

### Příklady srovnání dveří:

