

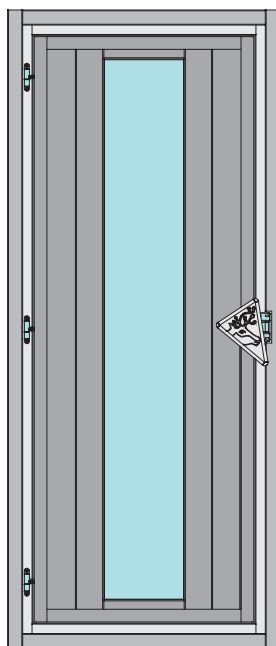



70341





-  **Aufbauanleitung**
-  **Building Instructions**
-  **notice de montage**
-  **montagehandleiding**
-  **Montagevejledning**
-  **Instrucciones de construcción**
-  **Istruzioni per il montaggio**
-  **Montážní návod**
-  **Navodila za sestavljanje**

 Vergleichen Sie zuerst die Material-liste mit Ihrem Paketinhalt! Bitte haben Sie Verständnis, dass Beanstandungen nur im nicht aufgebauten Zustand bearbeitet werden können!

 Vergelijk eerst de lijst van materialen met de inhoud van uw pakket! Reclamaties kunnen alleen in behandeling worden genomen zolang de onderdelen nog niet zijn gemonteerd!

 Confrontate questa distinta materiali prima con il contenuto del pacchetto! Vi preghiamo di comprendere che eventuali reclami possono essere accolti solo prima del montaggio!

 First compare the list of materials with your package contents! Please understand that complaints can be processed in the non-built status only!

 Start med at kontrollere materialelisten med indholdet af den leverede pakke! Vi gør venligst opmærksom på at reklamationer kun kan behandles for materialer som ikke er blevet bearbejdet!

 Nejprve překontrolujte obsah balení podle materiálového listu! Mějte pochopení pro to, že případnou reklamaci se můžeme zabývat pouze tehdy, když díly nebudou smontované! Za pomoci tohoto seznamu můžete jednotlivé díly přiřadit k montážnímu návodu.

 Commencez par comparer la liste du matériel avec le contenu de votre paquet! Sachez que nous traitons uniquement les réclamations concernant le matériel à l'état non monté!

 En primer lugar, compare la lista de material con el contenido del paquete. Rogamos entienda que las reclamaciones sólo pueden ser tramitadas antes de montar el objeto!

 Najprej primerajte seznam materialov z vsebino vašega paketa! Upoštevajte, da lahko pritožbe obravnavamo le v neseštavljenem stanju!

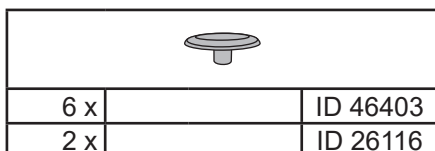
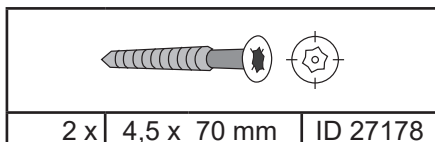
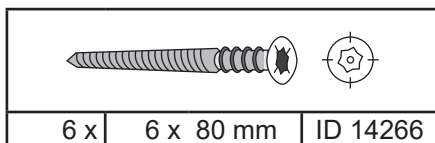
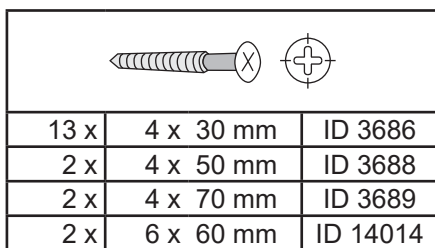
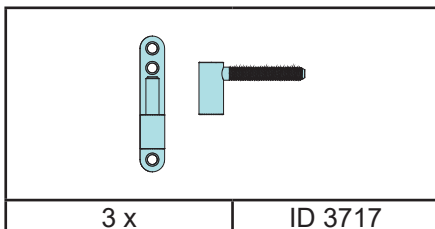
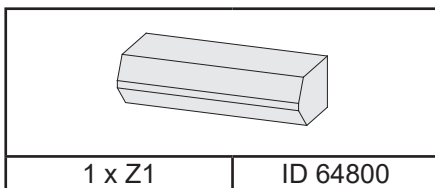
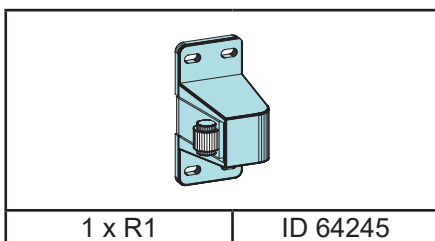
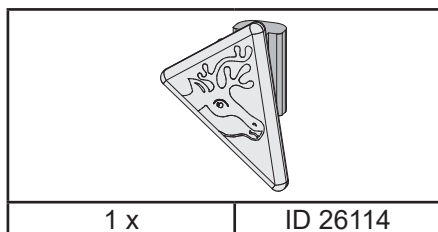
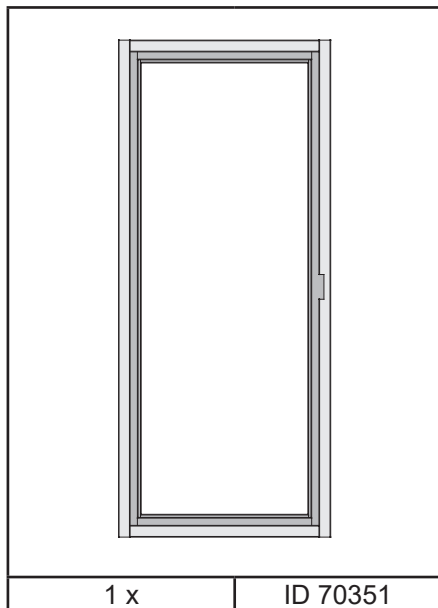
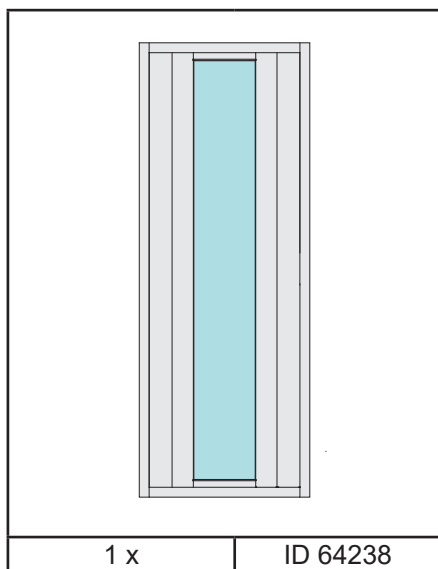
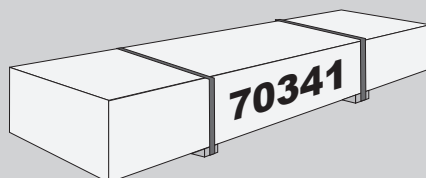





 Bitte beachten Sie, dass es sich bei einem Spontanbruch infolge von Nickelsulfideinschlüssen um Glasbrüche handelt, die nicht auf Verarbeitungsfehler basieren und somit nicht durch den Hersteller und dem Verarbeiter zu vertreten sind. Der Spontanbruch ist als hinzunehmendes Allgemeinrisiko anzusehen.

Bitte haben Sie Verständnis, dass wir eine Nachlieferung nur gegen Berechnung ausführen können.

 Upoštevajte, da je spontano lomljenje zaradi vključkov nikljevega sulfida lomljenje stekla, ki ni posledica napak pri obdelavi, zato zanj proizvajalec in predelovalec nista odgovorna. Samodejni lom stekla je treba obravnavati kot splošno tveganje, ki ga je treba sprejeti.

Prosimo, upoštevajte, da lahko naknadno dobavo opravimo le proti plačilu.

-  Einbau Glastür
-  Installation of glass door
-  Montage porte en verre
-  Montage van de glazen deur
-  Installationsglasdør

-  Montaje de la puerta de cristal
-  Installazione portello di vetro
-  Sauna Instalace dveře
-  Vgradnja steklenih vrat

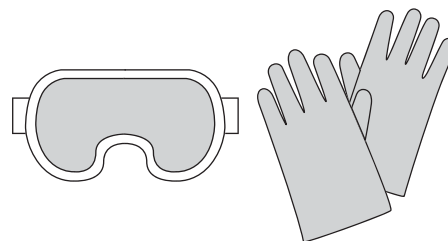

01

-  Tür in den Rahmen legen
-  Put the door in the frame
-  Mettez la porte dans le cadre
-  Plaats de deur in het frame
-  Sæt døren i rammen
-  Pon la puerta en el marco
-  Metti la porta nel telaio
-  Vložte dveře do rámu
-  Vrata namestite v okvir

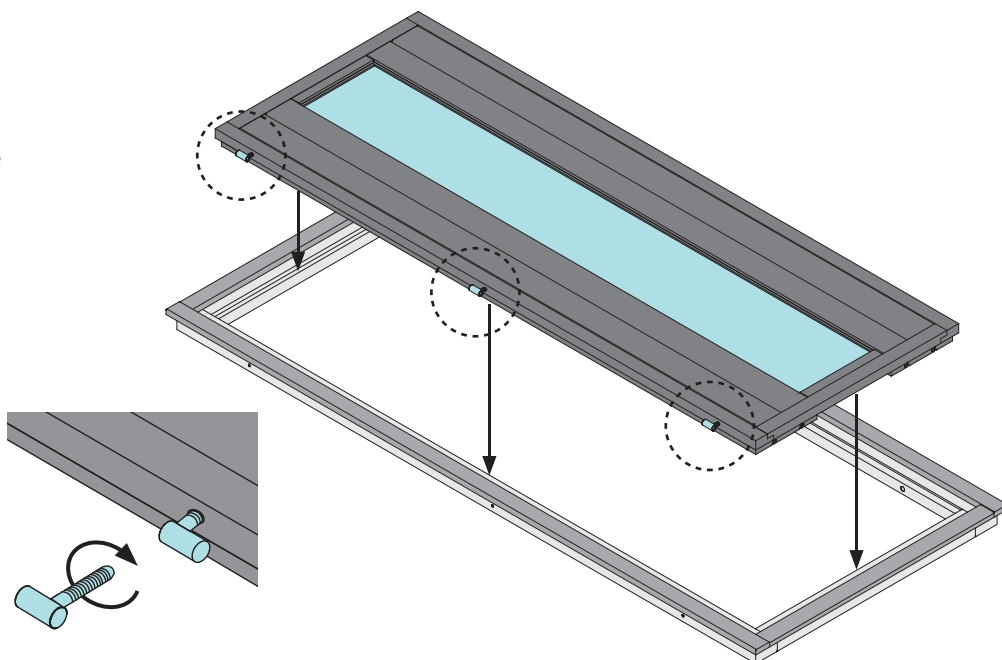

02

-  Tür im Rahmen ausrichten
-  Center the door in the frame
-  Aligner la porte dans le cadre
-  Lijn de deur in het frame uit
-  Juster døren i rammen
-  Alinea la puerta en el marco
-  Allinea la porta nella cornice
-  Zarovnejte dveře do rámu
-  Poravnajte vrata v okvir

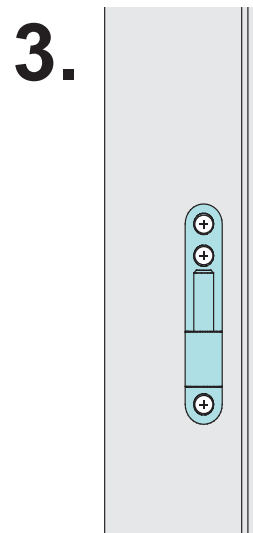
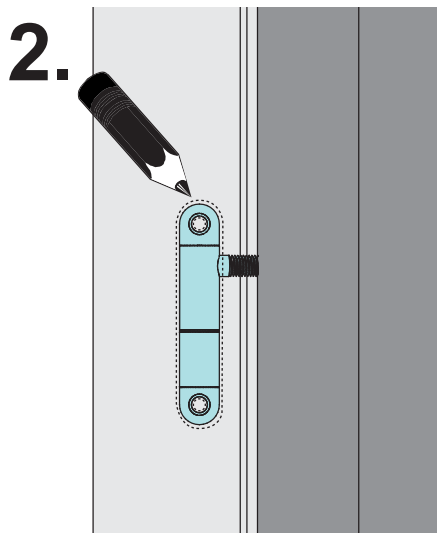
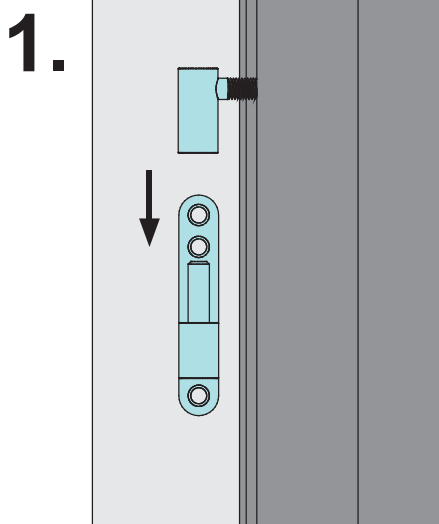
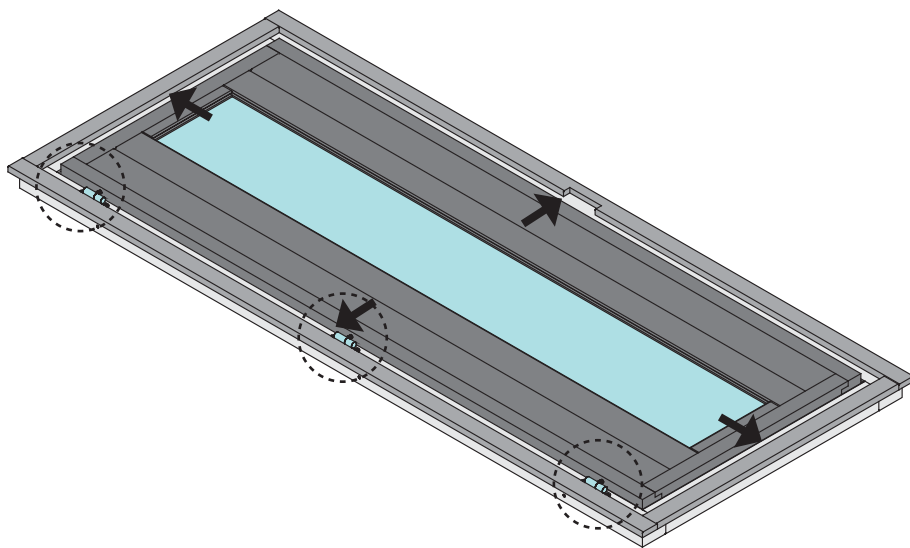

Ø3 mm 4x30
9x

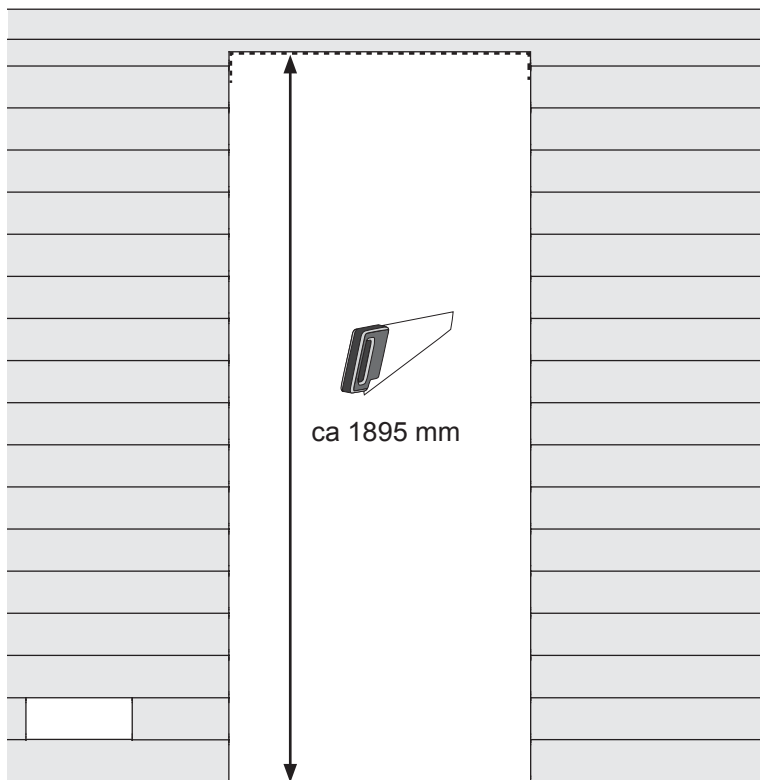

1.

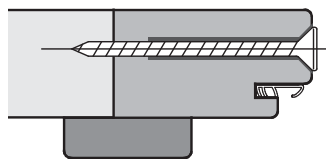
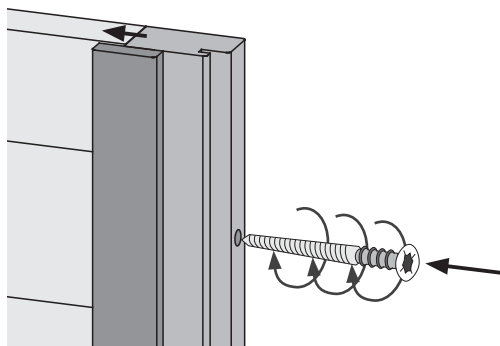

6x80

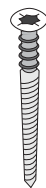

2.

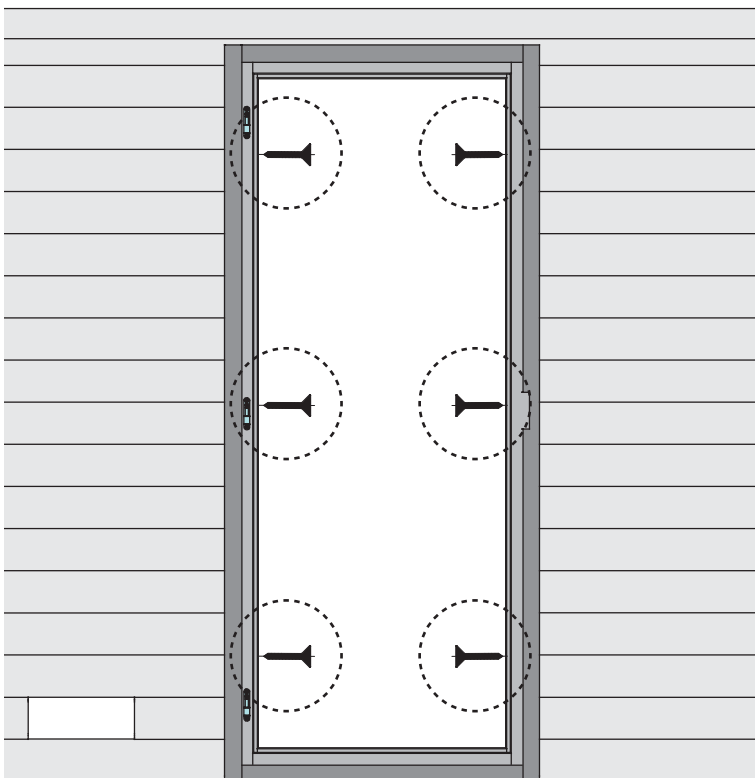
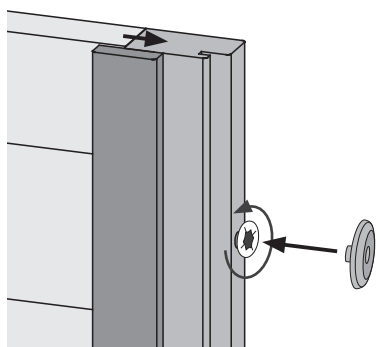

1.

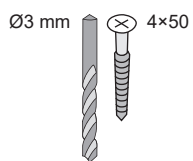
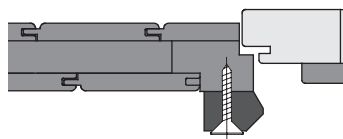

2x

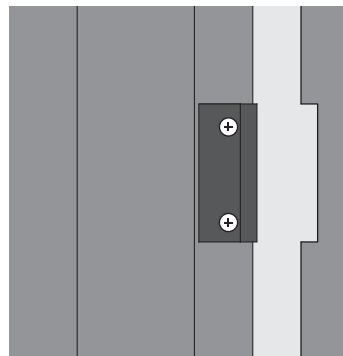

2.

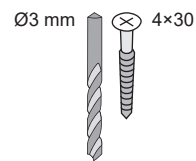
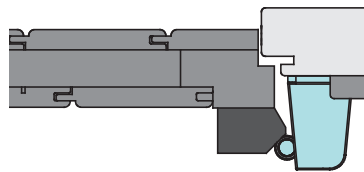

4x

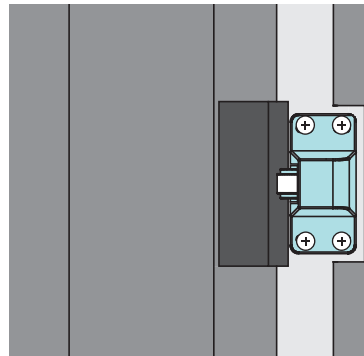

3.

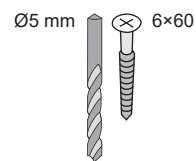
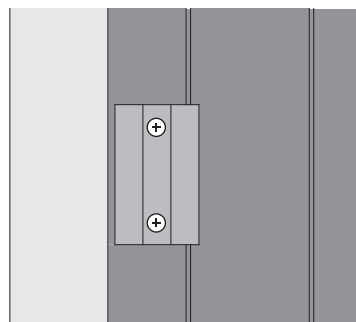
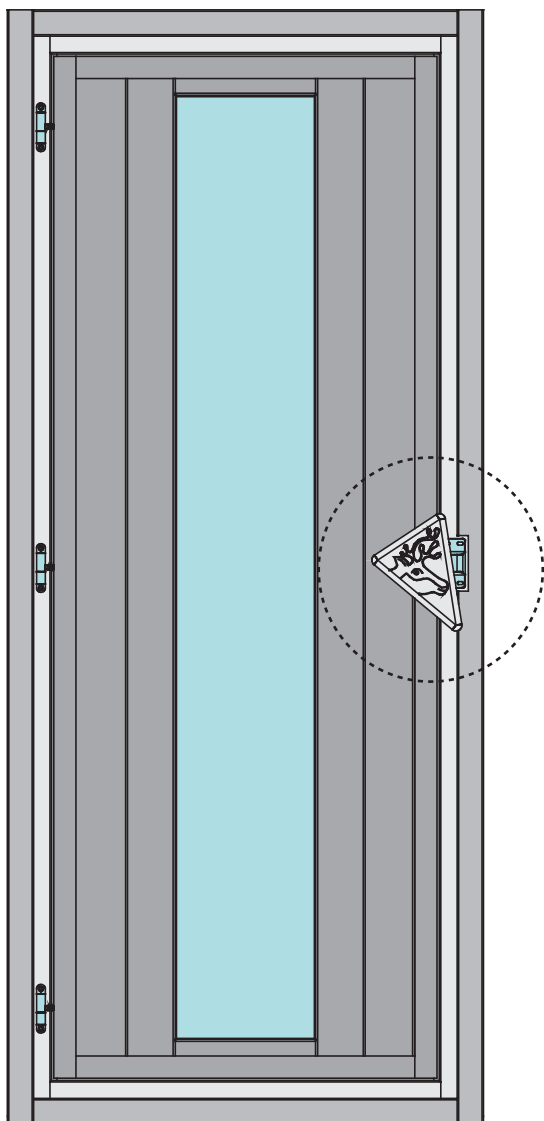

2x

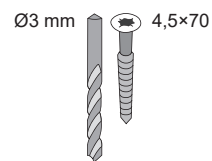
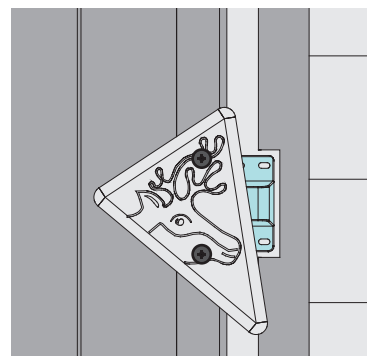
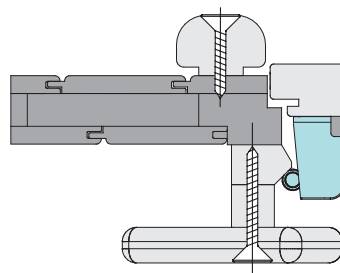

2x

