

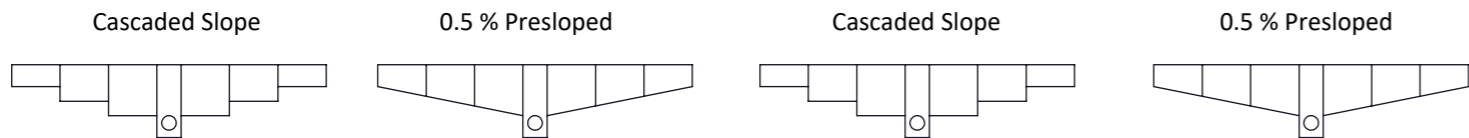

A channel with a vertical drain



Article	H/h, mm	Weight, kg	Article	H/h, mm	Weight, kg	Article	H/h, mm	Weight, kg	Article	H/h, mm	Weight, kg
4000/150	150	26,5	4000/150-145	150/145	26,3	400009/150	150	25,9	400009/150-145	150/145	25,7
4000/145	145	26	4000/145-140	145/140	25,8	400009/145	145	25,4	400009/145-140	145/140	25,2
4000/140	140	25,5	4000/140-135	140/135	25,3	400009/140	140	24,9	400009/140-135	140/135	24,7
4000/135	135	25	4000/135-130	135/130	24,8	400009/135	135	24,4	400009/135-130	135/130	24,2
4000/130	130	24,5	4000/130-125	130/125	24,3	400009/130	130	23,9	400009/130-125	130/125	23,7
4000/125	125	24	4000/125-120	125/120	23,8	400009/125	125	23,4	400009/125-120	125/120	23,2
4000/120	120	23,5	4000/120-115	120/115	23,3	400009/120	120	22,9	400009/120-115	120/115	22,7
4000/115	115	23	4000/115-110	115/110	22,8	400009/115	115	22,4	400009/115-110	115/110	22,2
4000/110	110	22,5	4000/110-105	110/105	22,3	400009/110	110	21,9	400009/110-105	110/105	21,7
4000/105	105	22				400009/105	105	21,4			

1. Dimensions for reference
2. Delivery and packaging are carried out in accordance with the terms of the contract
3. The manufacturer reserves the right, without notice to the consumer, to make changes to the design of the products for improvement of their technological and operational parameters, which will not affect the quality and properties of the product
4. Deviation of the actual weight of the nominal can be up to 10%.

UNLESS OTHERWISE SPECIFIED: DIMENSIONS ARE IN MILLIMETERS SURFACE FINISH: TOLERANCES: ISO 2768 - C LINEAR: ANGULAR:			 OBLIKUJEMO VODNE CESTE		DEBURR AND BREAK SHARP EDGES	DO NOT SCALE DRAWING	REVISION
NAME	SIGNATURE	DATE			TITLE: Betonska kanaleta 2PR FB Base		
DRAWN Olender		07.10.2022	ARTICLE:		A3		
CHK'D Kyselytsia			MATERIAL:				
APPV'D Malynovskiy			WEIGHT: kg				
MFG			SCALE:1:5				
QA			SHEET 1 OF 1				

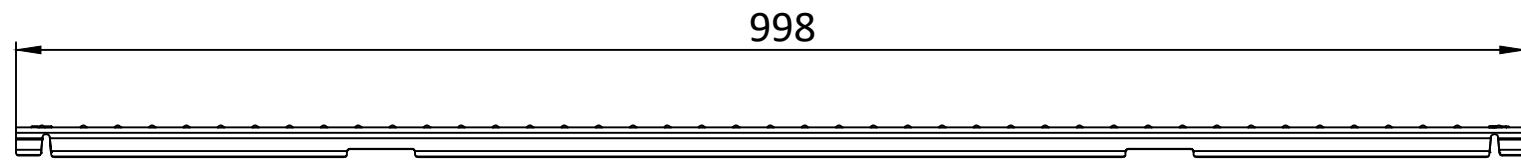
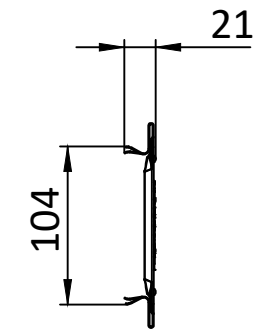
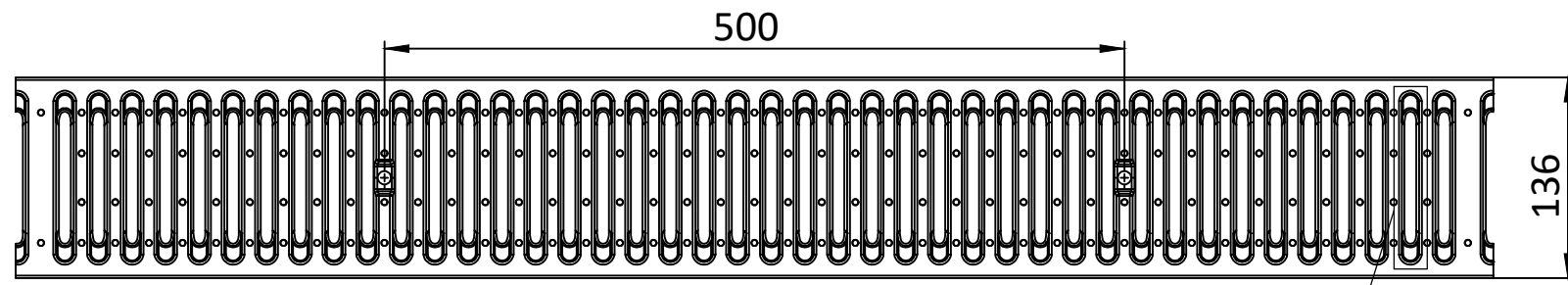

A (1 : 2)

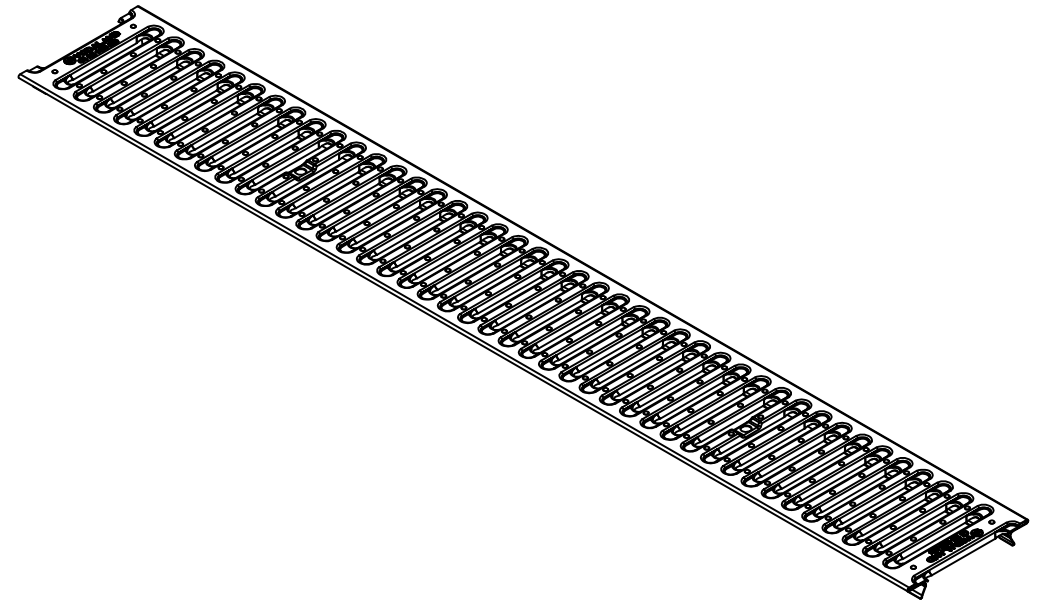
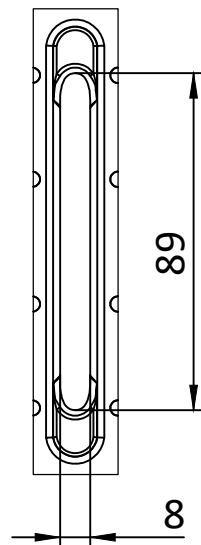

1. Deviation of the actual weight of the nominal can be up to 12%
2. Area of water intake slots 297,13 sq cm

UNLESS OTHERWISE SPECIFIED: DIMENSIONS ARE IN MILLIMETERS SURFACE FINISH: TOLERANCES: ISO 2768-b LINEAR: ANGULAR:				 OBLIKUJEMO VODNE CESTE		DO NOT SCALE DRAWING		REVISION	
NAME	SIGNATURE	DATE	TITLE:			Obremenilni razred A15		A3	
DRAWN	LIL	20.10.22	Vročē cinkana rešetka		2PR FB Base		SCALE:1:5		
CHK'D	LMK		Obremenilni razred A15		Obremenilni razred A15		SHEET 1 OF 1		
APPV'D			MATERIAL:						
MFG									
Q.A									