

1381

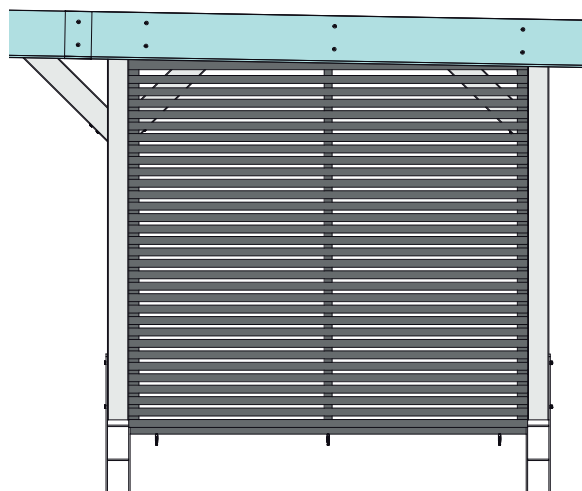

-  **Aufbauanleitung**
-  **Building Instructions**
-  **notice de montage**
-  **montagehandleiding**
-  **Montagevejledning**
-  **Instrucciones de construcción**
-  **Istruzioni per il montaggio**
-  **Montážní návod**
-  **Navodila za sestavljanje**

Bitte bewahren Sie die Anleitung und den Garantieschein zur Seriennummer auf.

Vernichten Sie diese erst nach Ablauf der Garantiezeit.

Eventuelle Beanstandungen können mithilfe der Stückliste einfacher zugeordnet werden.

Beigelegte Dokumente

- Informationsheft
- Garantieschein zur Seriennummer
- Typenschild inkl. Warnhinweise (Sauna)
- ggf. Zubehör-Anleitungen in externen Paketen

*

-  Nicht im Lieferumfang enthalten
-  Not included
-  Non comprises dans la livraison
-  Niet bijgeleverd
-  No forman parte del suministro
-  Non incluso
-  V ceně není zahrnuto
-  Ikke inkluderet
-  Ni vključeno v obseg dobave









2

-  Nicht gebraucht
-  Not needed
-  Pas nécessaire
-  Niet nodig
-  No es necesario
-  Non necessario
-  Není nutná
-  Ikke nødvendigt
-  Ne uporabljajte se

4

-  Fixiert vorübergehend
-  Fixed temporarily
-  Temporairement fixe
-  Tijdelijk vast
-  Temporalmente fijo
-  Temporaneamente fisso
-  Dočasně pevný
-  Midlertidigt rettet
-  Začasno popravi

1

-  Länge muss ermittelt und zugesägt werden
-  Length must be determined and sawn
-  La longueur doit être déterminée et sciée
-  De lengte moet worden bepaald en worden gezaagd
-  La longitud debe ser determinada y aserrada
-  La lunghezza deve essere determinata e segata
-  Délka musí být určena a rozřezána
-  Længden skal bestemmes og savnes
-  Določiti je treba dolžino in jo odrezati po velikosti.

3

-  Mit Zubehör
-  With accessories
-  Avec accessoires
-  Met toebehoren
-  Con accesorios
-  Con accessori
-  S příslušenstvím
-  Med tilbehør
-  Z dodatki

5

-  Bestand vom Haus
-  Inventory of the house
-  Inventaire de la maison
-  Inventaris van het huis
-  Inventario de la casa
-  Inventario della casa
-  Inventář domu
-  Inventar af huset
-  Inventarizacija hiše

 Vergleichen Sie zuerst die Material-liste mit Ihrem Paketinhalt! Bitte haben Sie Verständnis, dass Beanstandungen nur im nicht aufgebauten Zustand bearbeitet werden können!

 First compare the list of materials with your package contents! Please understand that complaints can be processed in the non-built status only!

 Commencez par comparer la liste du matériel avec le contenu de votre paquet! Sachez que nous traitons uniquement les réclamations concernant le matériel à l'état non monté!

 Vergelijk eerst de lijst van materialen met de inhoud van uw pakket! Reclamaties kunnen alleen in behandeling worden genomen zolang de onderdelen nog niet zijn gemonteerd!

 Start med at kontrollere materialelisten med indholdet af den leverede pakke! Vi gør venligst opmærksom på at reklamationer kun kan behandles for materialer som ikke er blevet bearbejdet!



 En primer lugar, compare la lista de material con el contenido del paquete. Rogamos entienda que las reclamaciones sólo pueden ser tramitadas antes de montar el objeto!

 Confrontate questa distinta materiali prima con il contenuto del pacchetto! Vi preghiamo di comprendere che eventuali reclami possono essere accolti solo prima del montaggio!



 Nejprve přezkontrolujte obsah balení podle materiálového listu! Mějte pochopení pro to, že případnou reklamaci se můžeme zabývat pouze tehdy, když díly nebudou smontované! Za pomoci tohoto seznamu můžete jednotlivé díly přiřadit k montážnímu návodu.



 Najprej primerajte zoznam materialov z vsebino vašega paketa! Upoštevajte, da lahko pritožbe obravnavamo le v nesestavljenem stanju!

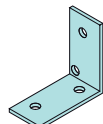

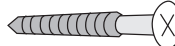
		
2 x A1	2200 x 58 x 28 mm	ID 31667

	
8 x	ID 21208

		
65 x	4 x 30 mm	ID 3686
70 x	4 x 40 mm	ID 21925
8 x	4 x 70 mm	ID 3689

		
32 x B1	2250 x 45 x 18 mm	ID 20633
1 x B2	2250 x 58 x 18 mm	ID 21834
1 x B3	2250 x 78 x 18 mm	ID 93421
1 x B4	2251 x 58 x 28 mm	ID 42545
1 x B5	2238 x 60 x 40 mm	ID 563

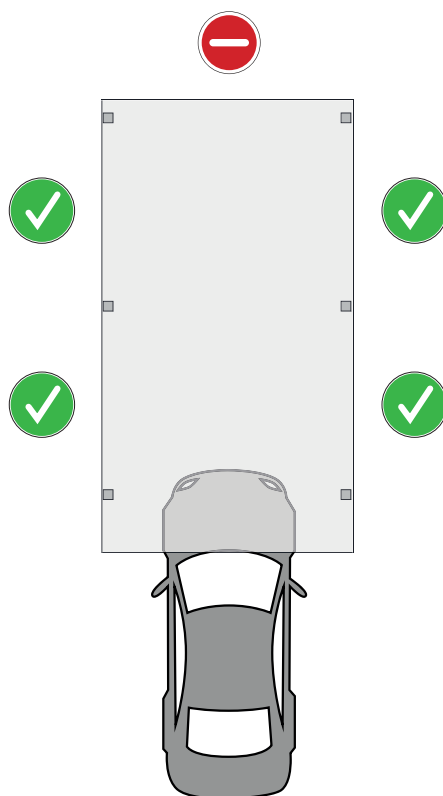
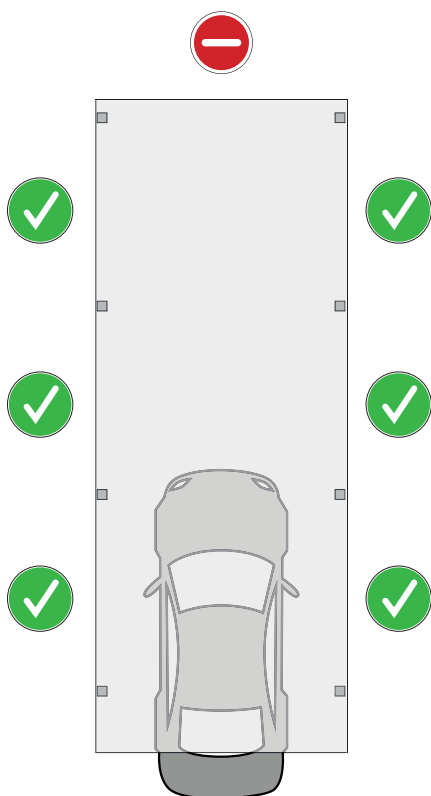

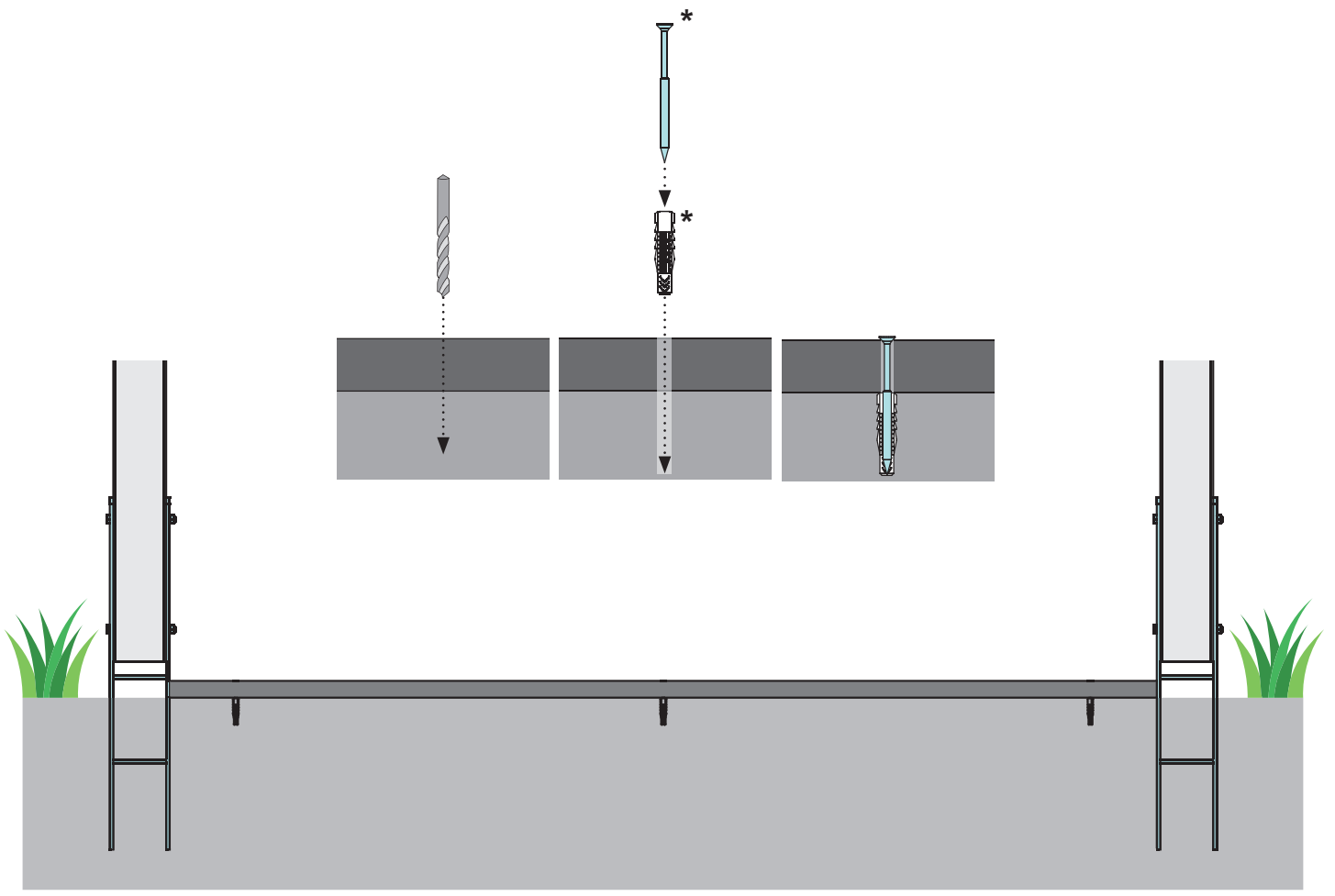
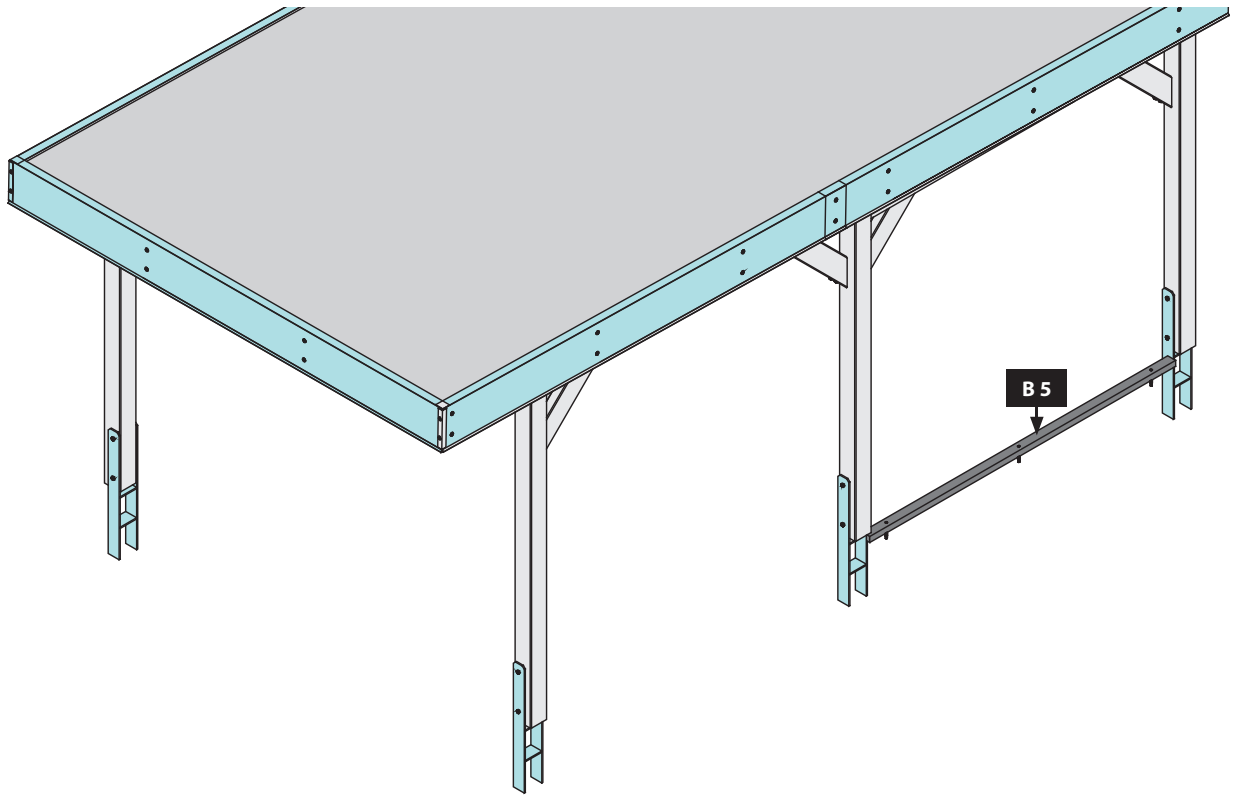

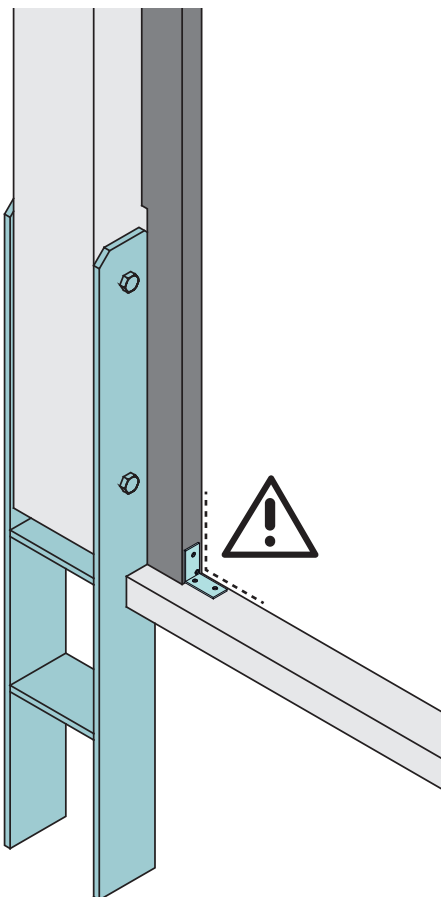
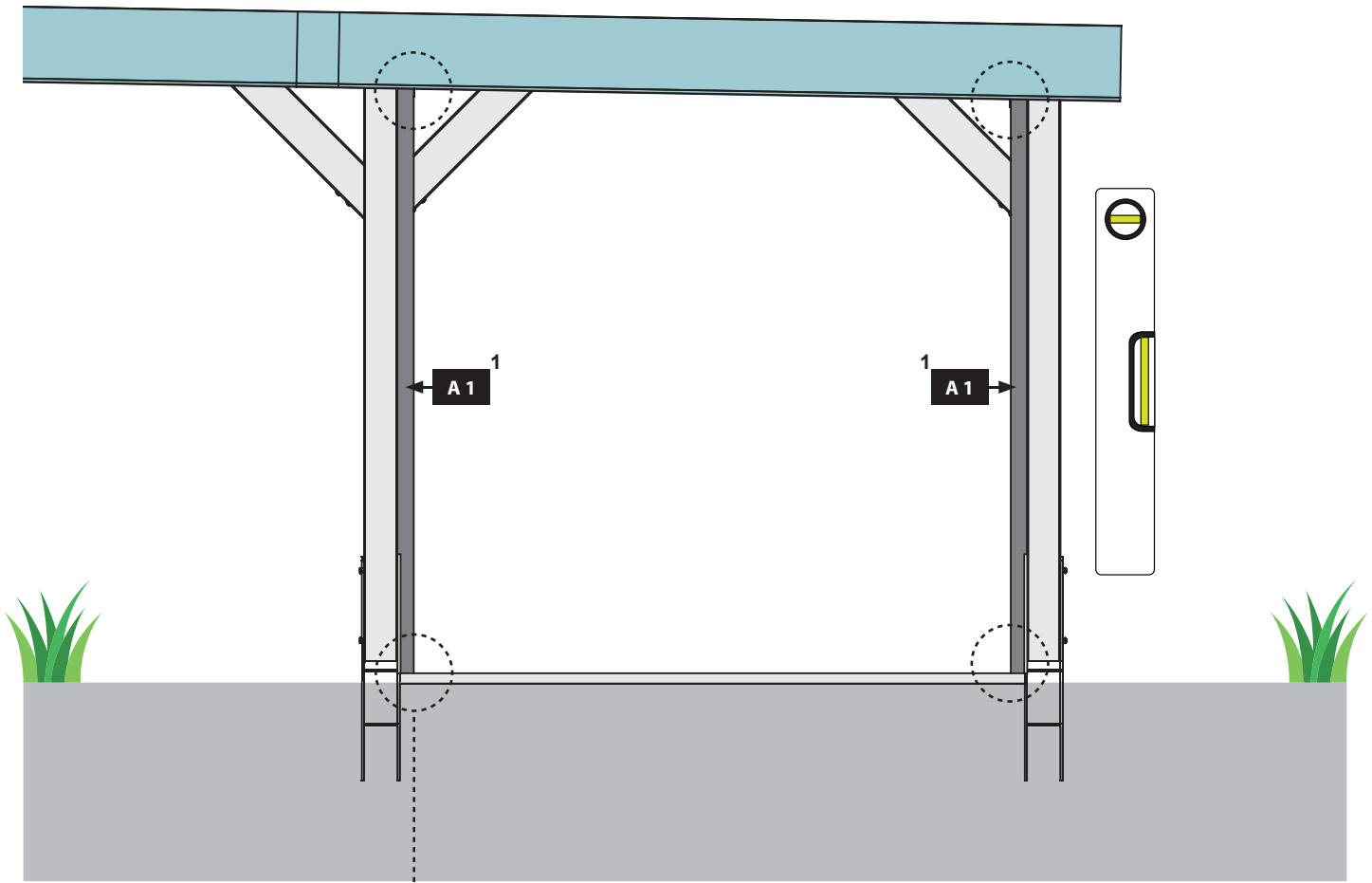

16x
Ø3 mm 4x30

4x

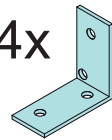

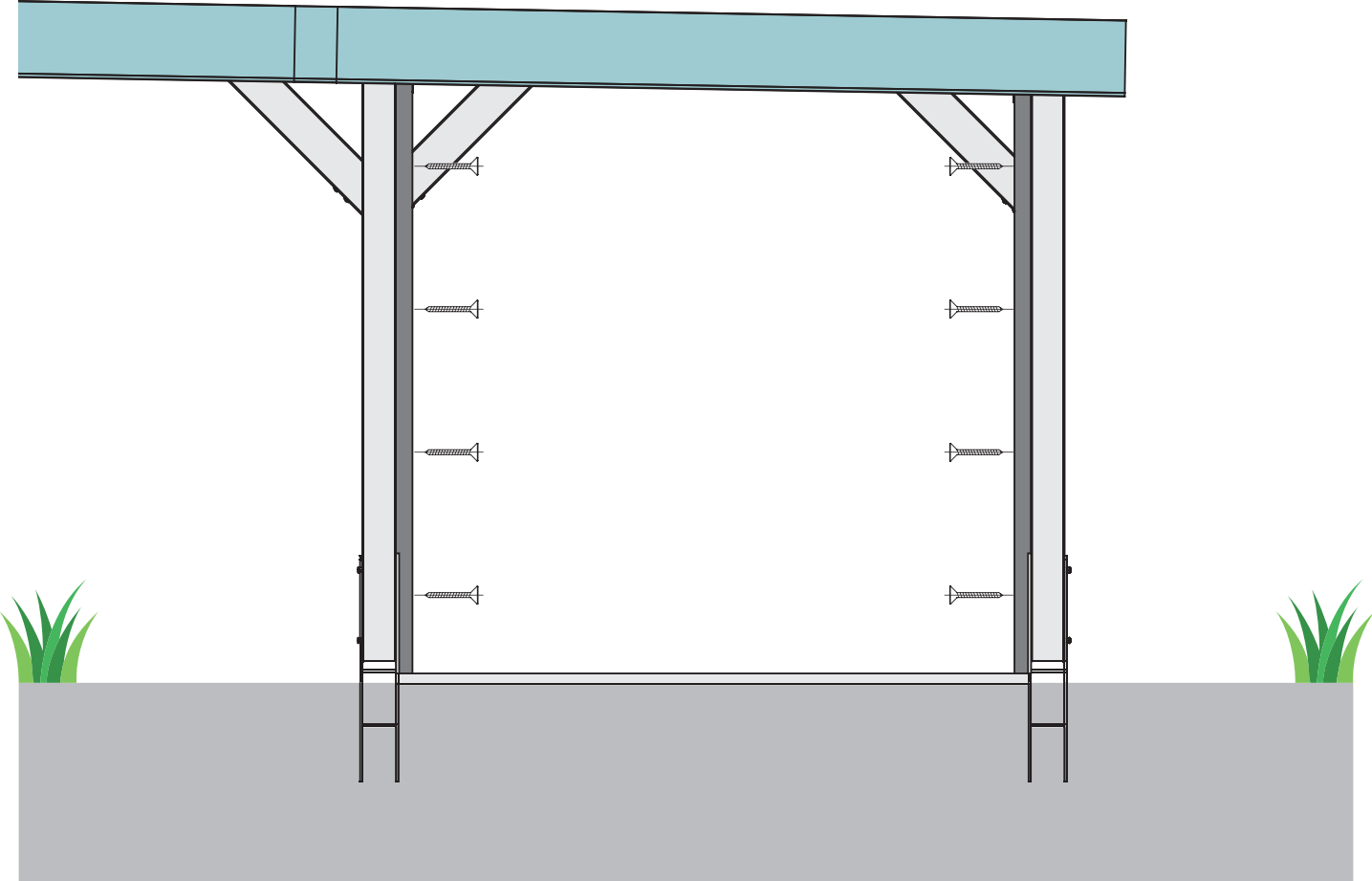
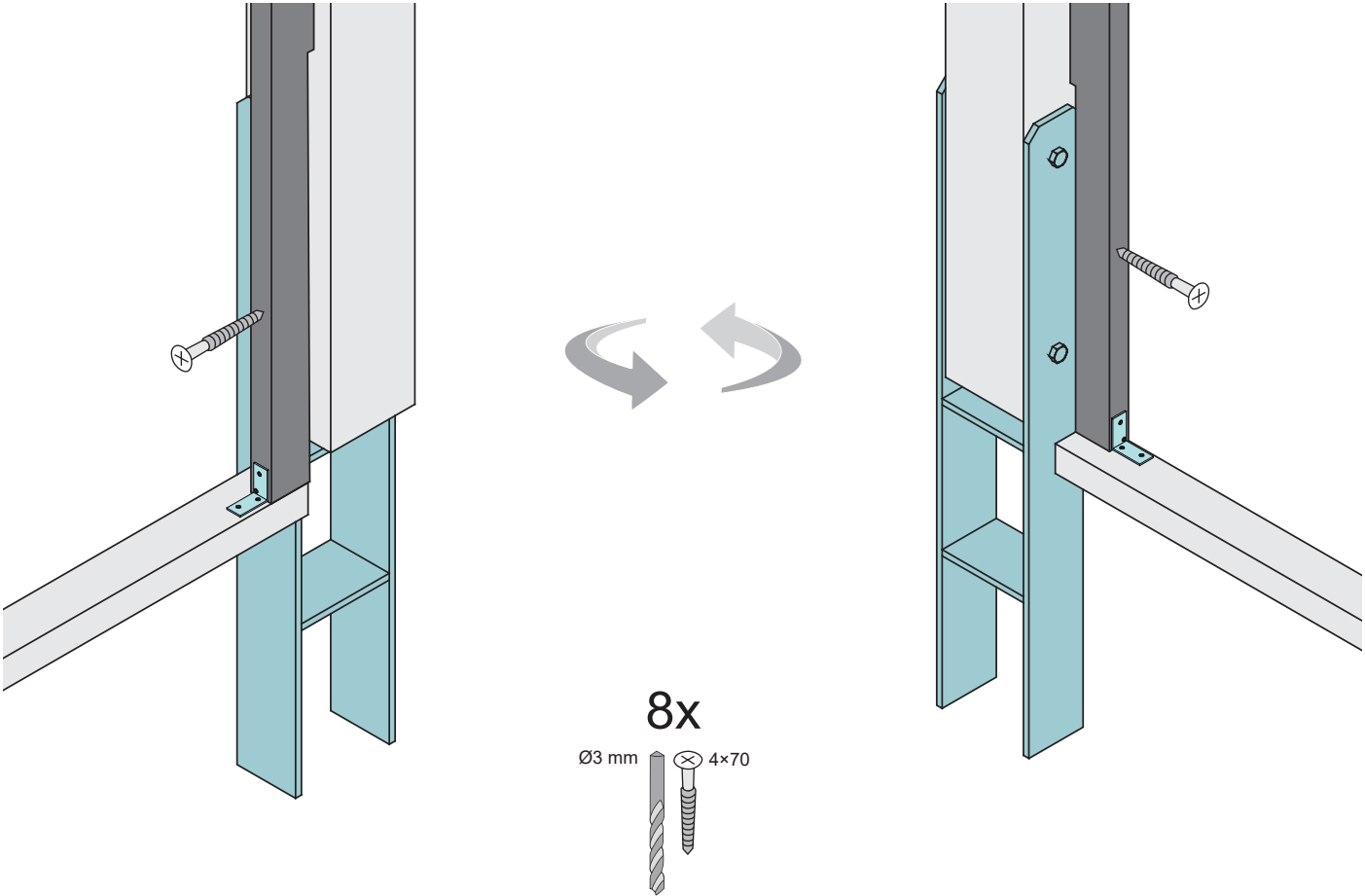

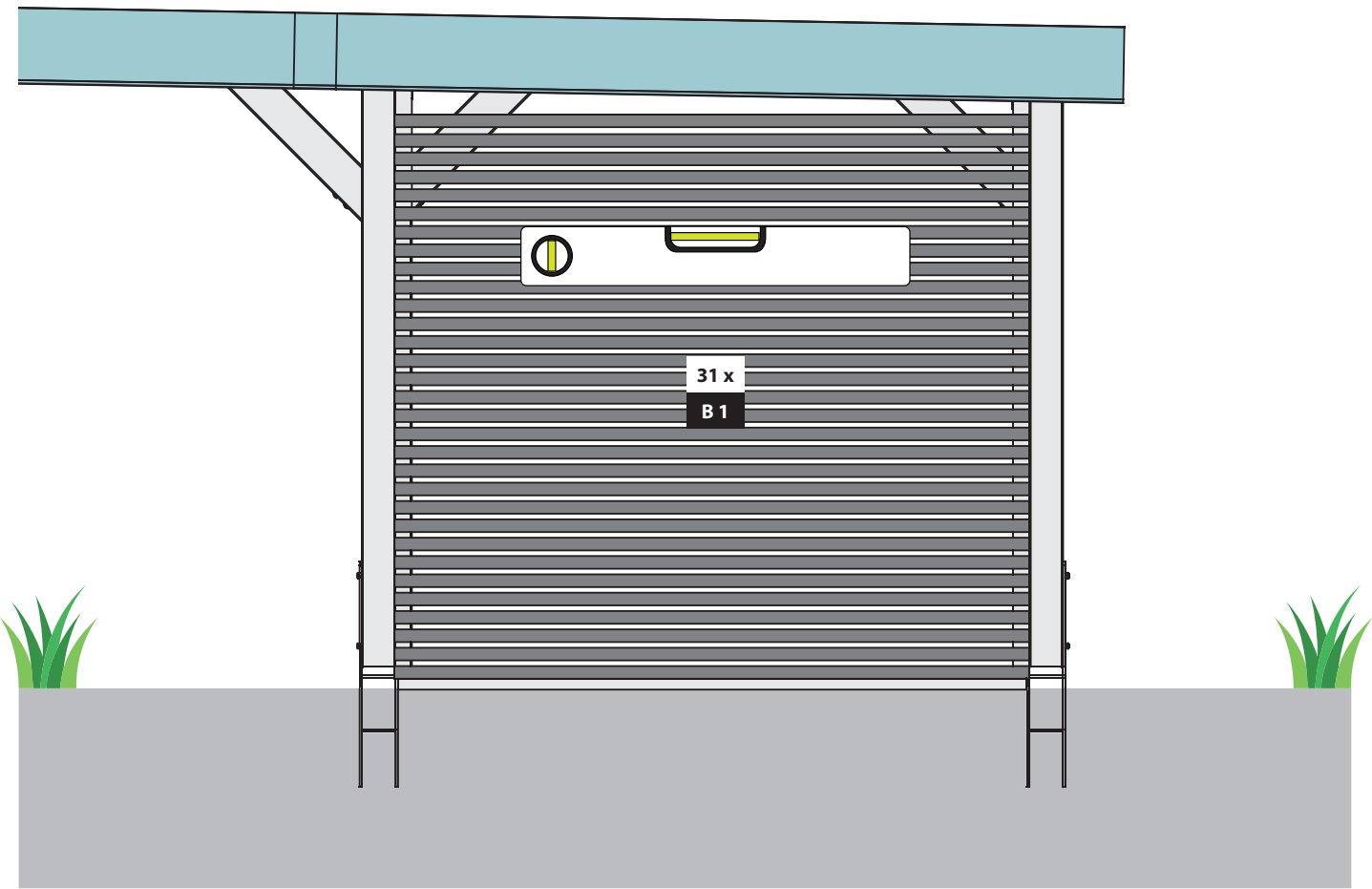
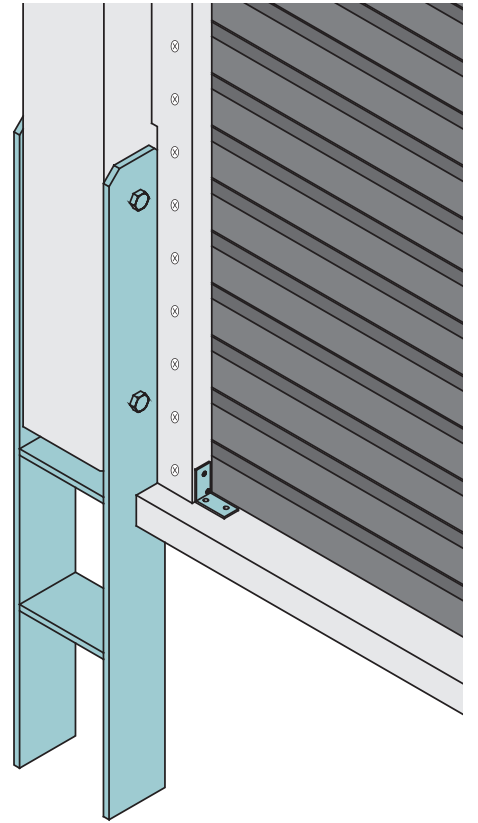
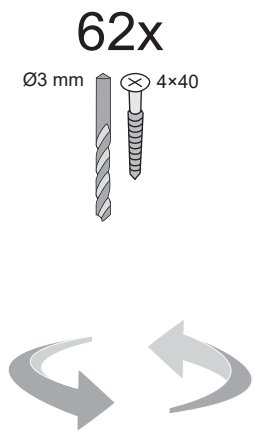
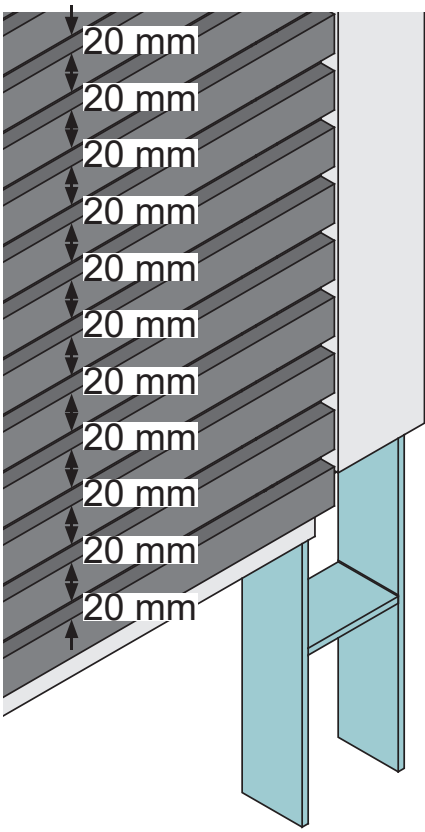

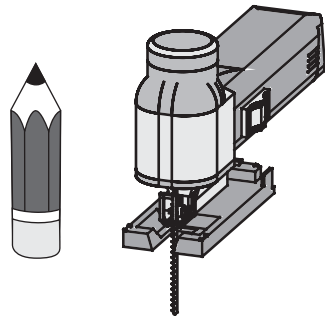

1
B 3

